

Overview of Flat Rolled Steel Processes

Steel Manufacturing, Testing and Products

Table of Contents

Basics	What is Steel?
Steel Grades	Plain Carbon grades, Automotive Grades, Structural grades
Mill types	Integrated vs Mini-mills, Hot Rolling
Pickling	Types, benefits and common imperfections
Cold Rolling	Cold Roll Strip, Sheet, one pass
Annealing	Purpose, types and benefits
Temper Rolling	Temper rolling vs other ways to flatten steel
Coated Products	Galvanize, Galvanneal and Aluminized
Testing	Various testing methods used to evaluate Steel

Section I: Basics



What is a metal/steel?

Metal: An element whose electrons* aren't bound to particular atoms and have a partially filled valence band.

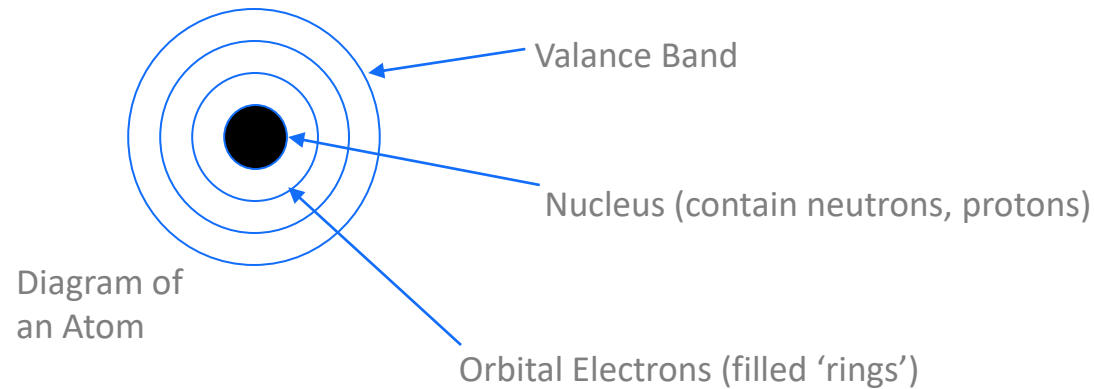

Steel: **Iron + Carbon (usually less than 1%)**
A hard, strong, gray or bluish-gray alloy of iron with carbon and usually other elements, used extensively as a structural and fabricating material.

**Free electrons in outer ring (valance) are free to move throughout metal – that's why metals conduct heat, electricity.*

What is microstructure?

Microstructure – The fine structure of materials (in a metal or other material), such as, type, size and arrangement of grains that determine material properties, which can be made visible at 100x+ magnification and examined with a microscope.

Types of Microstructure

Ferrite: BCC - Iron (Fe) (low solubility for Carbon).

Cementite: Iron Carbide (Fe_3C).

Pearlite: Two phase microstructure composed of Ferrite and Cementite forms at 1000F-1341°F (one goal of annealing, the cementite spheroidizes).

Austenite: Present at temperatures above 1414°F; high solubility of carbon (100x greater than ferrite).

Martensite: Formed when austenitic steel is rapidly cooled preventing diffusion of carbon (like a supersaturated solution).

Bainite: Consists of Ferrite and Cementite forms at lower temp than pearlite (420-1000°F).

Microstructure can help predict the behavior and/or failure in certain conditions of a component made of a particular material.

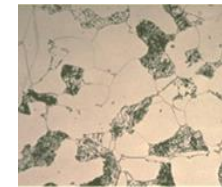

SAE 1020 HR
STEEL

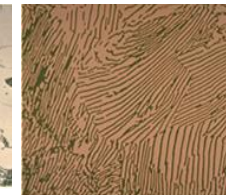

SAE 1080 HR
STEEL

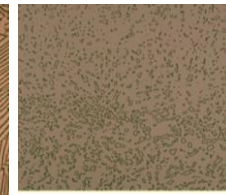

SAE 1050 CR
STEEL

Periodic Table of Elements

Legend:
 Atomic number: 1 (top left), 6 (top middle)
 Symbol: C (top middle)
 Atomic weight: 12.01 (top middle)
 Metal: Red background
 Semimetal: Green background
 Nonmetal: Yellow background

1	2											13	14	15	16	17	18
1 H 1.008												5 B 10.81	6 C 12.01	7 N 14.01	8 O 16.00	9 F 19.00	10 Ne 20.18
3 Li 6.941	4 Be 9.012											13 Al 26.98	14 Si 28.09	15 P 30.97	16 S 32.07	17 Cl 35.45	18 Ar 39.95
11 Na 22.99	12 Mg 24.31	3	4	5	6	7	8	9	10	11	12	13	14	15	16	17	18
19 K 39.10	20 Ca 40.08	21 Sc 44.96	22 Ti 47.88	23 V 50.94	24 Cr 52.00	25 Mn 54.94	26 Fe 55.85	27 Co 58.93	28 Ni 58.69	29 Cu 63.55	30 Zn 65.39	31 Ga 69.72	32 Ge 72.61	33 As 74.92	34 Se 78.96	35 Br 79.90	36 Kr 83.80
37 Rb 85.47	38 Sr 87.62	39 Y 88.91	40 Zr 91.22	41 Nb 92.91	42 Mo 95.94	43 Tc 98.91	44 Ru 101.1	45 Rh 102.9	46 Pd 106.4	47 Ag 107.9	48 Cd 112.4	49 In 114.8	50 Sn 118.7	51 Sb 121.8	52 Te 127.6	53 I 126.9	54 Xe 131.3
55 Cs 132.9	56 Ba 137.3	71 Lu 175.0	72 Hf 178.5	73 Ta 180.9	74 W 183.8	75 Re 186.2	76 Os 190.2	77 Ir 192.2	78 Pt 195.1	79 Au 197.0	80 Hg 200.6	81 Tl 204.4	82 Pb 207.2	83 Bi 209.0	84 Po 209.0	85 At 210.0	86 Rn 222.0
87 Fr 223.0	88 Ra 226.0	103 Lr 262.1	104 Rf 261.1	105 Db 262.1	106 Sg 263.1	107 Bh 264.1	108 Hs 265.1	109 Mt 266	110 Uun 269	111 Uuu 272	112 Uub 277	113 Uut 289	114 Uuq 289	115 Uup 289	116 Uuh 289	117 Uus 289	118 Uuo 293
		57	58	59	60	61	62	63	64	65	66	67	68	69	70		
		La 138.9	Ce 140.1	Pr 140.9	Nd 144.2	Pm 146.9	Sm 150.4	Eu 152.0	Gd 157.3	Tb 158.9	Dy 162.5	Ho 164.9	Er 167.3	Tm 168.9	Yb 173.0		
		89	90	91	92	93	94	95	96	97	98	99	100	101	102		
		Ac 227.0	Th 232.0	Pa 231.0	U 238.0	Np 237.0	Pu 244.1	Am 243.1	Cm 247.1	Bk 247.1	Cf 251.1	Es 252.0	Fm 257.1	Md 258.1	No 259.1		

(c)1998
Kremer Paul



Steel is a *Metal* but not an *Element*!

Steel is a metal because it is composed mainly of Iron [Fe] which makes it a ferrous alloy but it depends upon the level of Carbon [C] in it.

- Iron < 0.008 wt% C (generally; one exception is *IF* family of steels)
- Steel 0.008 wt% to 2.11 wt% C
- Cast Iron 2.11 wt% to 6.7 wt% C
- Example: Typical ASTM 1008 steel has 0.04 wt% C so for every 100lbs. of steel there is 0.04 lbs. of C.
- It doesn't take a lot of C or other elements to affect the properties of steel.

Low Carbon vs. High Carbon

Weight
Percent of
all elements
other than
Fe in Steel

USST E44917		LAB ANAL	
TAG	> 04 631749-00		
WT	49870	01	
A/C	1006 BOR AK	1006 BOR	CON
C	.037	.037	
MN	.260	.259	
P	.010	.010	
S	.009	.010	
SI	.010	.010	
CU/SN	.010 .001	.014	.003
NI	.010	.011	
CR	.020	.015	
MO	.003	.003	
AL	.040	.039	
V	.001	.001	
NB	.001		
ZR/N	.00400		
TI/O	.001	.001	
B /H	.0040	.0032	
CA/LC			
CO/LS		.002	
DFCT			
DATE	08/20/02	09/06/02	

Total non-Fe elements: 0.421% 0.418%

404_ 229290		LAB ANA	
TAG	> 04 566713-00		
WT	42620	00	
A/C	1050	1050	SK
C	.480	.468	
MN	.810	.770	
P	.009	.010	
S	.002	.004	
SI	.241	.239	
CU/SN	.074 .012	.079	.010
NI	.058	.059	
CR	.122	.117	
MO	.018	.016	
AL	.027	.024	
V		.003	
NB	.001		
ZR/N	.01100	.001	
TI/O	.003	.003	
B /H		.0001	
CA/LC		.0018	
CO/LS		.004	
DFCT	Y63.7 T107.4	CR CA	
DATE	03/19/02	04/03/02	

1.868% 1.809%

Fe-C Phase Diagram

The Phase Diagram is a chart that tells when the steel solidifies depending upon wt% C and the kind of microstructure it will have including the crystal structure.

The red bordered area is the area that is considered steel.

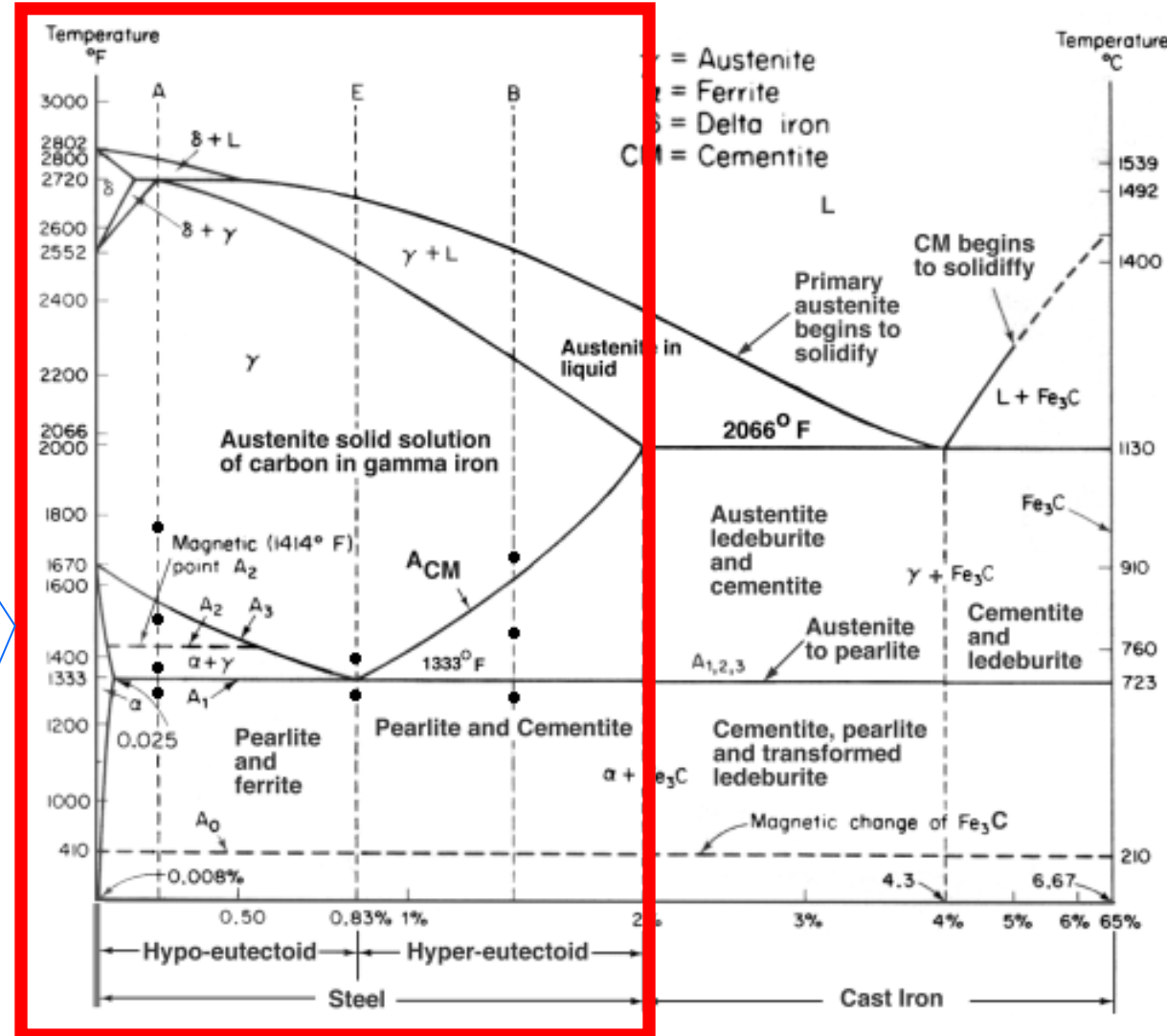

Crystal Structure of Steel and Formation of Grains

Diagram of Solidification

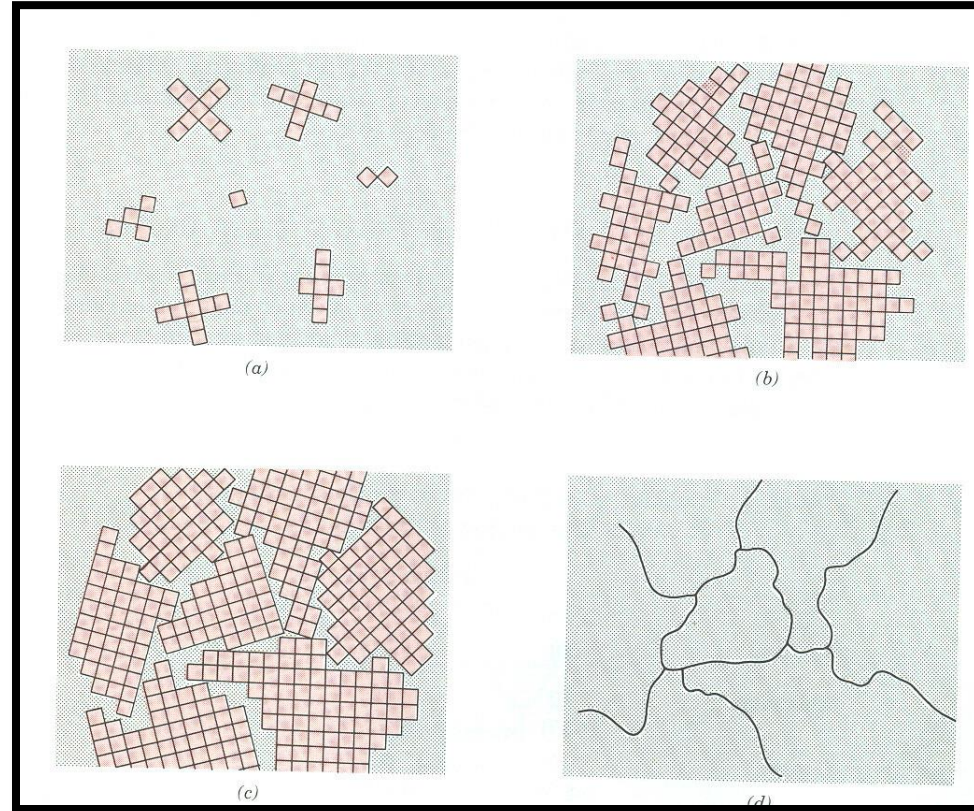

So... What is Microstructure??

Microstructure – Type, size and arrangement of grains that make up a material.

Grain – Groups of atoms with a similar arrangement.

Grains intersect at grain boundaries forming the *microstructure*.

Grains grow at different rates depending upon composition, time, temperature, and rate of temperature change.

FCC crystal structure (100% above ~1672°F)

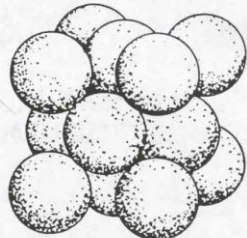
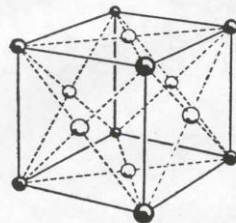

BCC crystal structure (starts developing under ~1672°F)

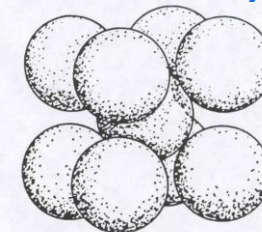
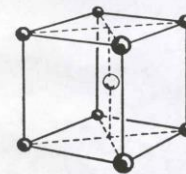

Section II: Grades



The Steel Tree – Plain Carbon and HSLA

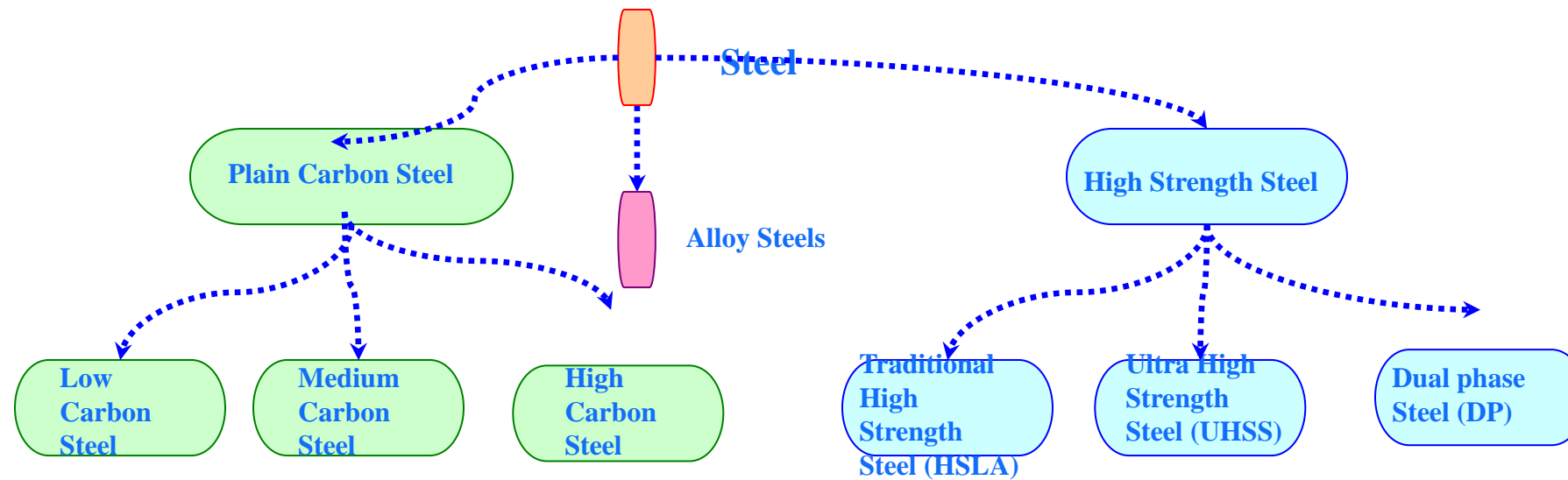

Low carbon – offered as basic grade or as structural grade.

Medium carbon – offered as basic grade or structural grade

High carbon - offered as basic grade

Specifications – can be to recognized standard or customer specific.

Part forming/customer expected properties critical to know for non structural grades

HSLA – structural members where weight is a consideration

UHSS – safety members in cars

Dual Phase (DP) – applied in areas which require higher forming for required TS, crumple zones.

Specifications – can be to recognized standard or customer specific.

Part forming critical for CR HSLA grades, less so for standard grades

Types / grades of steel

Low Carbon

Hot Rolled Grades

- Commercial Steel (CS)
- Drawing Steel (DS)
 - option boron
 - need to exercise caution on using boron

Cold Rolled Grades

- Commercial Steel (CS)
- Drawing Steel (DS)
- Deep Drawing Steel (DDS)
- Extra Deep Drawing Steel (EDDS)
- Vacuum Degassed / IF

Hot Rolled vs Cold Rolled

Hot Rolled Steel

- Black or pickled surface
- Heavier thicknesses
- Wider gauge tolerance
- Not as flat
- Less mechanical property control

Cold Rolled Steel

- Uniform/smooth surface
- Lighter thicknesses
- Tighter gauge tolerance
- Improved flatness
- More mechanical property control

Types / grades of steel

Low Carbon

Commercial Steel (CS)	Drawing Steel (DS/DDS)	Extra Deep Drawing Steel (EDDS)
Carbon up to .15	Carbon under .08/.06	Vacuum Degassed to remove carbon/nitrogen and improve cleanliness -Ti and/Nb added to combine with any remaining C/N
Higher hardness -CR: 45-65 RB -HR: 55-75 RB	Lower hardness -CR: 40-55 RB -HR: 60-6 RB	Cold rolled to produce pancake grain structure for resistance to thinning (higher Rvalue/drawability)
Bending and simple forming	More difficult forming, stretching, drawing	Lowest strength/Highest formability -Hardness under 40 RB -Nvalue .23-.27 -Rvalue 1.7-2.1
		Used in most difficult/complex, deep drawn parts -Avoid progressive dies due to cold work embrittlement (hardenability)

Types / grades of steel

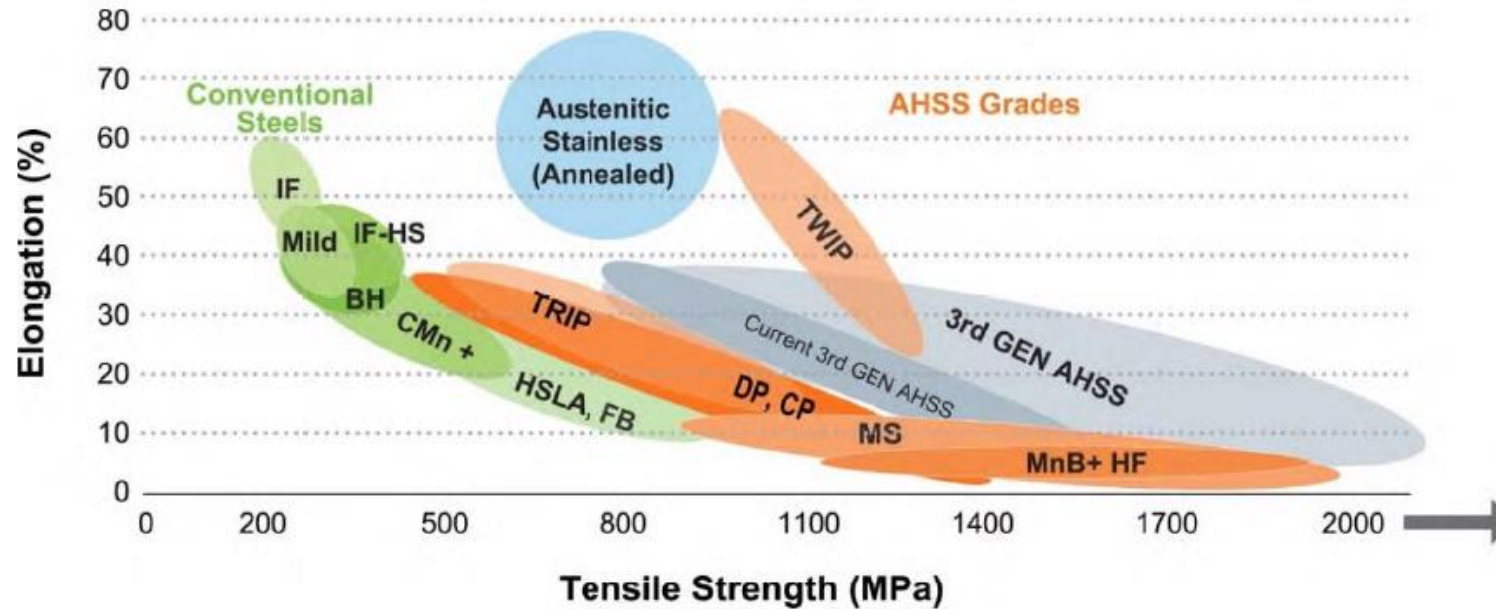

XX	Type of steel	XX	Type of steel
HSLA	High Strength, Low Alloy	TRIP	Transformation Induced Plasticity
DP	Dual Phase	MS	Martensitic (MART)
CP	Complex Phase	TWIP	Twinning-Induced Plasticity
FB	Ferritic Bainitic	HF	Hot Formed (and quenched)
Q & P	Quenching & Partitioning	TPN	Three Phase Nano-Precipitation

Tensile strength (TS) is the capacity of a material or structure to withstand loads tending to elongate. Tensile strength resists tension (being pulled apart). It is measured by the maximum stress that a material can withstand while being stretched or pulled before breaking.

Types / grades of steel

MULTIPHASE Structure → Manage Phase Transformation → Coupled Key Factors: PROCESS and CHEMICAL COMPOSITION

PROCESS = control the structure at high temperature + the continuous cooling

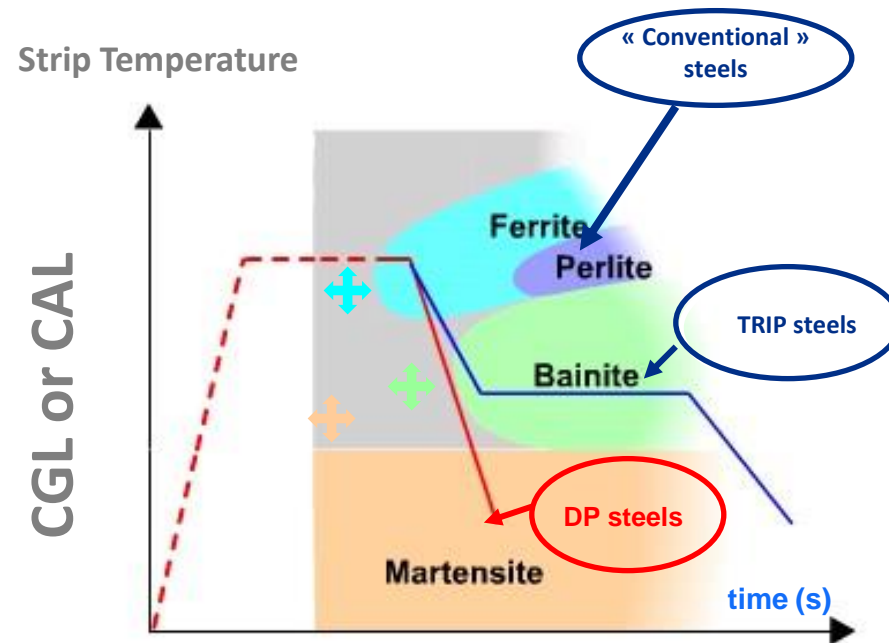

Adjusted by chemical composition and processing



Area of Ferrite formation during cooling



Area of Bainite formation during cooling



Area of Martensite formation during cooling

Types / grades of steel

Press Hardened Steels (PHS)

- Hot Stamped Steels, Boron Steels
- Medium carbon boron steels – similar to 10B21
- Excellent formability at elevated temperatures
- Processing: austenitize, hot form, in-die quench
- Oxide removal and corrosion protection: Bare vs. aluminized vs. zinc

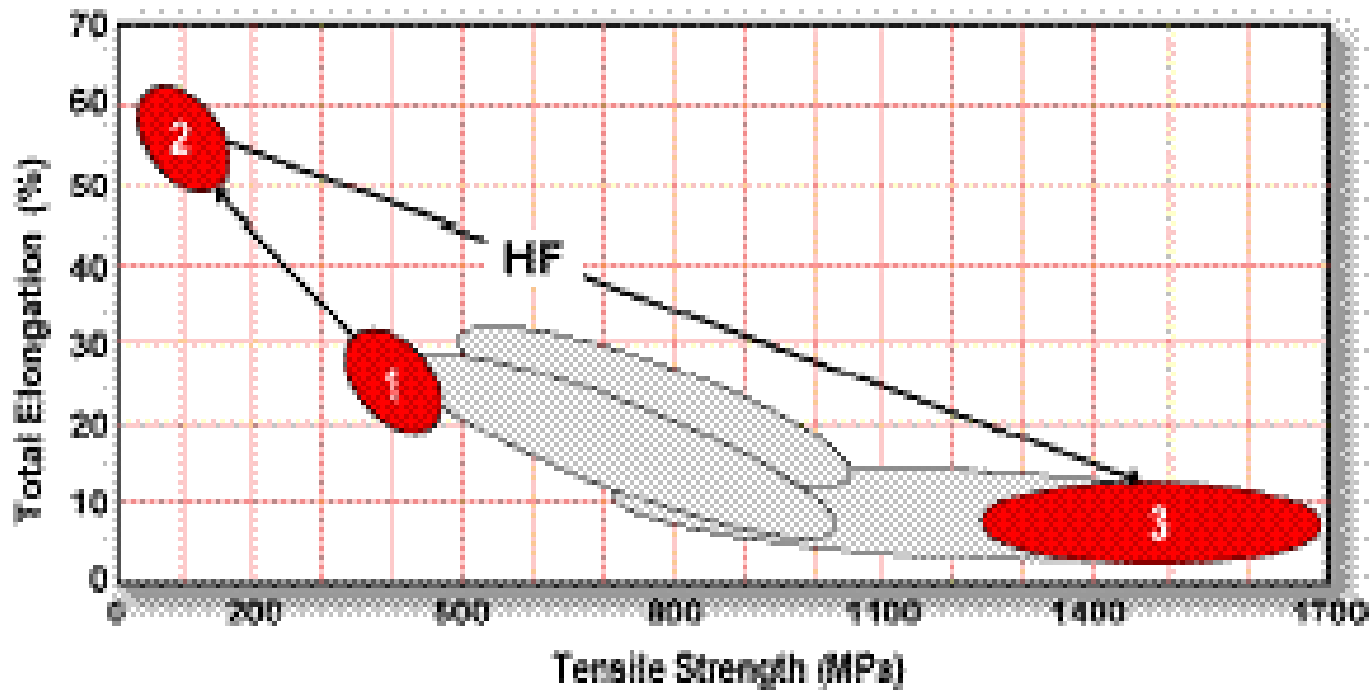

Types / grades of steel

- Ferrite matrix with islands of hard martensitic second phase.
- Continuous soft ferrite phase for excellent ductility.
- Strain concentrates in lower strength ferrite phase for unique high work hardening rate.
- Available in different strength levels. Specified by minimum tensile strengths of 490, 590, 780, 980 and 1180 MPA.
- Most applications are Cold Rolled or coated Cold Rolled.

Ferrite-Martensite DP

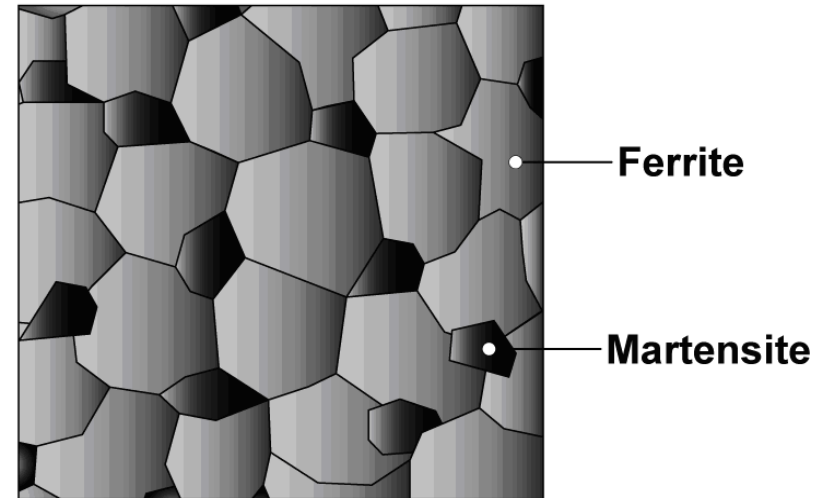

Types / grades of steel

- Dispersion of hard second phases in soft ferrite creates initial high work hardening rate.
- Retained austenite also progressively transforms to martensite with increasing strain.
- Transformation increases work hardening at higher strain levels.
- Typically used in place of DP where formability is an issue.
- Available in different strength levels. Specified by minimum tensile strengths of 590, 690, 780 and 980 MPA.
- Most applications are Cold Rolled or coated Cold Rolled.

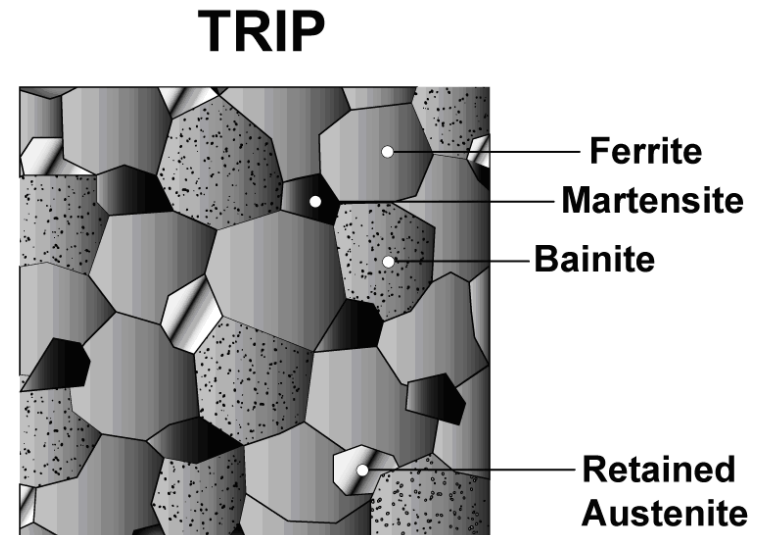

Types / grades of steel

Complex Phase (CP)

- Ferrite/bainite matrix with martensite, retained austenite and pearlite and fine precipitates
- Very fine grains (V, Ti and/or Nb)
- Hot rolled
- Good energy absorption
- Relatively small usage

Ferritic-Bainitic Steels (FB)

- Fine ferrite/bainite
- Strength from fine grains and bainite
- Excellent edge stretchability
- Hot rolled
- Also called stretch flangeable (SF) or High Hole Expansion (HHE)

Types / grades of steel

Martensitic Steels

- Austenite transforms almost completely to martensite due to quenching on the run-out table (HR) or cooling section of a continuous annealing line (CR).
- Highest tensile strength AHSS.
- Must be electrogalvanized due to loss of mechanical properties during hot dip galvanizing.
- Typically roll formed due to limited formability for uses such as side door reinforcement or bumpers

Section III: Mill Types

Integrated Steelmaking – process flow

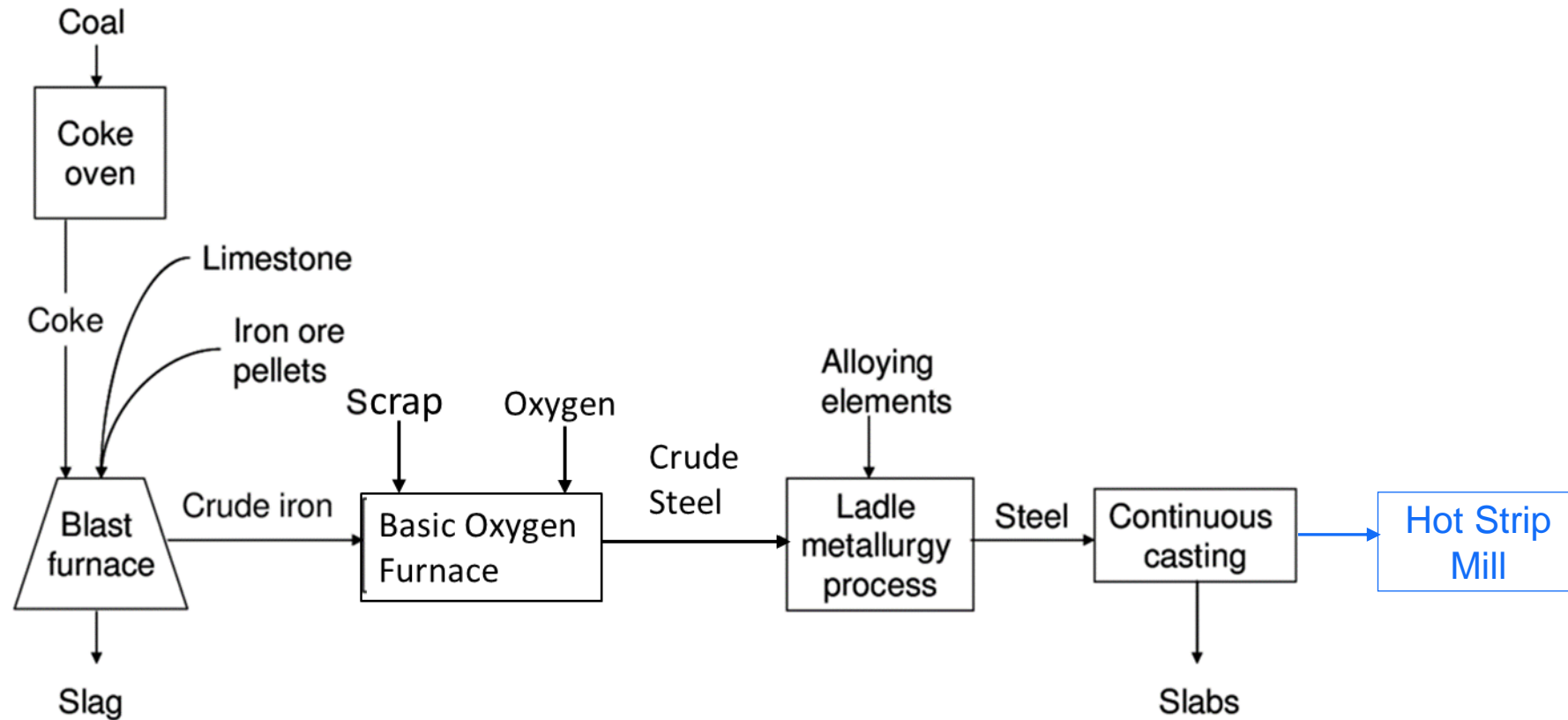

YouTube video

Steel from Start to Finish: <https://www.youtube.com/watch?v=9l7JqonyoKA>

Integrated Steelmaking

Iron Ore (pelletized)



Naturally occurring source of iron

Coke (purified Coal)

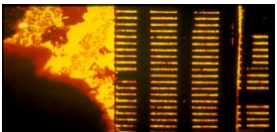

Fuel Source to generate heat and CO/CO₂

Limestone/Dolomite



Fluxing agent to remove impurities (slag)

Heated Air

Supersonic heated air used to react with coke, travels @ ~450-650 mph, 1700-2400°F; largest ingredient by weight!

Diagram of a Blast Furnace

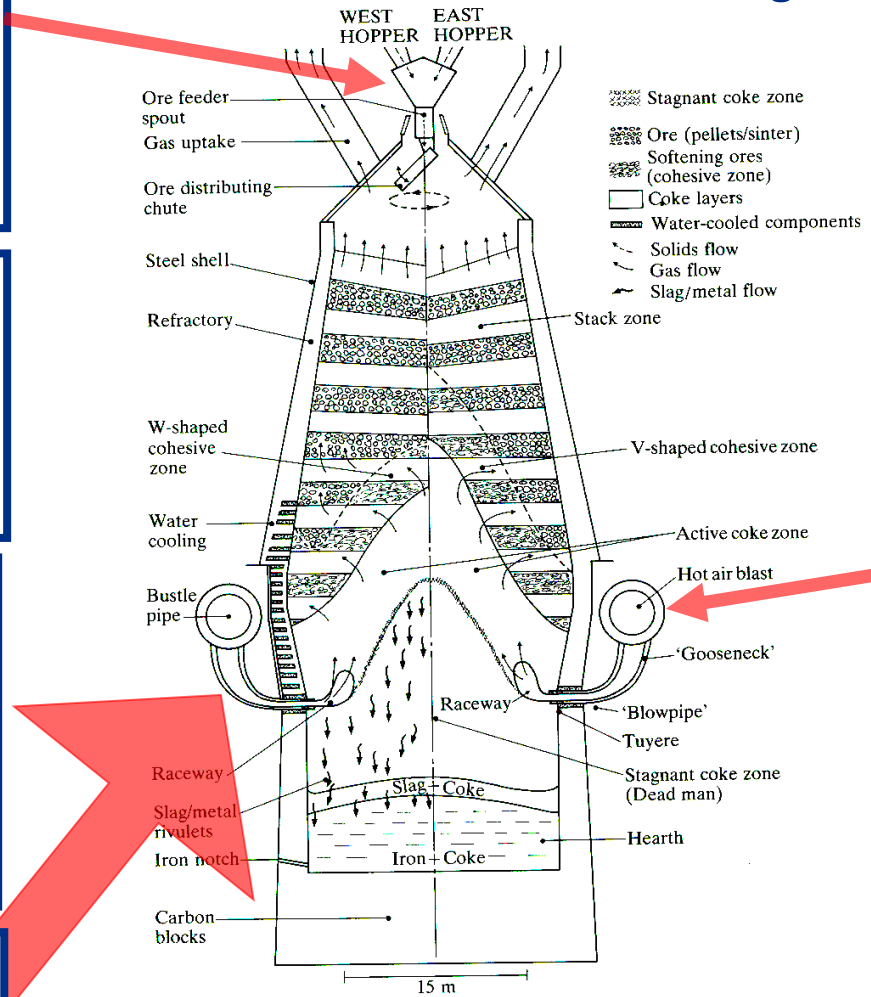

Pig Iron (liquid)



Tapped and leaves in torpedo car to BOP

Steelmaking

Ladle Metallurgy Facility (LMF)

- **Deoxidizing (Killing)**
 - removes oxygen content during steel manufacturing
- **Desulphurization**
 - removes sulfur from a mineral resource
- **Argon Stirring**
 - opens an eye in the slag
 - float out inclusions
- **Alloying Additions**
 - bulk / Wire
- **Temperature control**
 - electrode
- **Vacuum Degassing/Decarburizing**
- **Ingot and wire alloy feed for precise chemistry**

Steelmaking – BOF & LMF

Refinement of Pig Iron to “Steel-like” Chemistry (BOF)

- Scrap charged
- Hot metal (Pig Iron) charged
 - treated with Ca first & skimmed to keep high S & P out of the BOF
- Calcium / Flux added
- Commercially pure O₂ blown into vessel
 - “burn out” C, Mn, Si
 - chemical reactions add the heat
 - react P & S into slag

What does it mean to “kill” a Steel?

- Oxygen is blown through liquid iron to remove carbon to produce steel.
- Once carbon is reduced, there is still a lot of oxygen in heat of steel.
- Liquid steel can hold more oxygen in solution than solid steel.
- Have to remove oxygen or bubbles will form in steel as it cools.
- When the oxygen is removed, the steel is ‘killed’.
- Generally all steels today are ‘killed’ with aluminum.
 - Aluminum is a better oxidizer than silicon.
 - Forms less dense oxides.
 - AK steels tend to be cleaner internally.
 - Ties up N better than Si*** does.

**** Si killed steels today generally would only be required for some case-hardened, electrical or carburized applications.*

Steelmaking

Steelmaking - Degassing

Process of removing Carbon from liquid steel to produce ultra-low Carbon steel with improved ductility. Removal of O₂, H₂, and N₂ gases from liquid steel is also necessary since these gases harm the properties of steel.

R-H Degasser

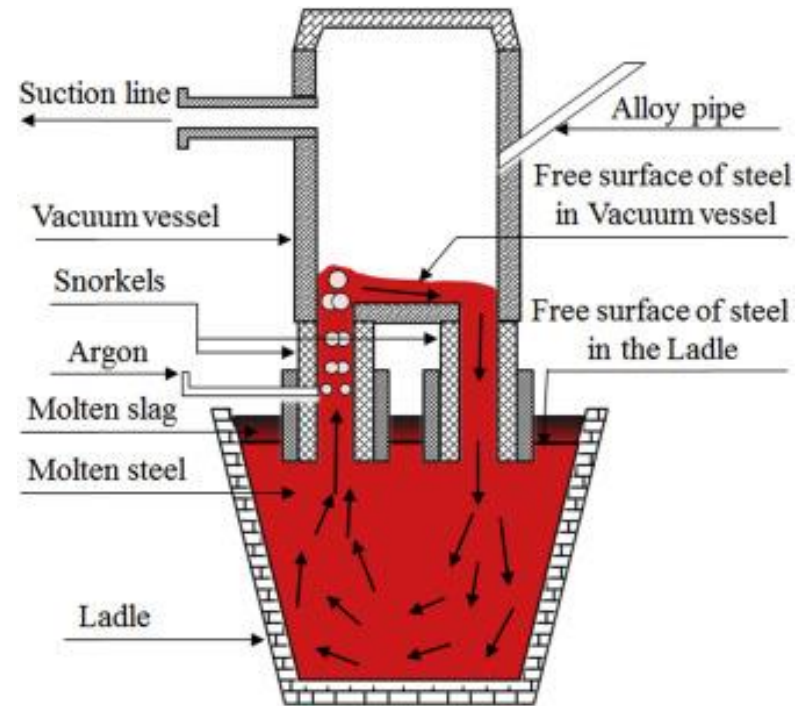

Cycle time: Chamber is moved 50-60 times with a cycle time of 20 seconds. Adequate degassing is possible in 20-30 cycles.

Steelmaking

Converting liquid metal into slab, solidifying into shape

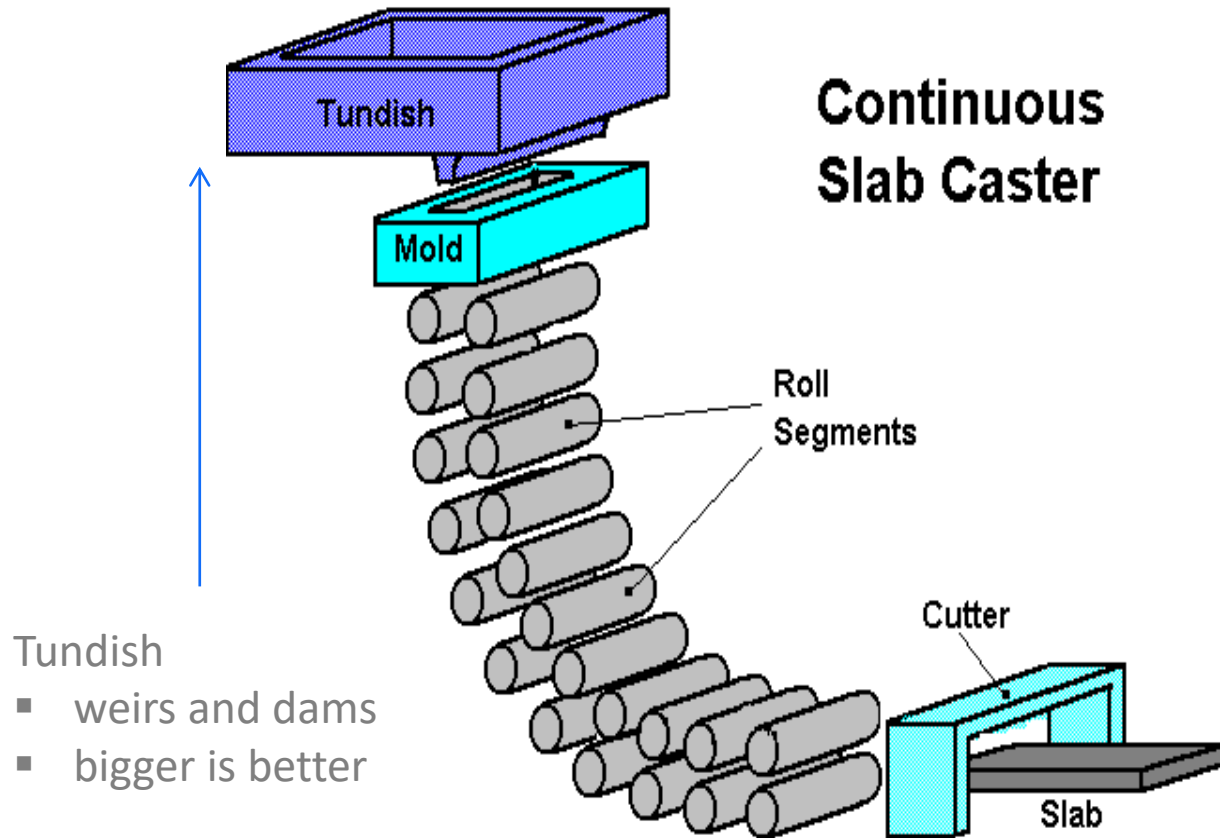

- Tundish
- weirs and dams
 - bigger is better

Continuous Casting

Steel Products

- Flat Products
 - Plate
 - Hot Rolled Sheet
 - Coated Sheet
 - Cold Rolled Sheet
 - Cold Rolled Strip



Source: Worthington Steel

Steelmaking

Continuous Casting

The Mold

- **Mold powder purpose**
 - thermal insulation
 - prevents re-oxidization
 - absorbs inclusion
 - lubrication

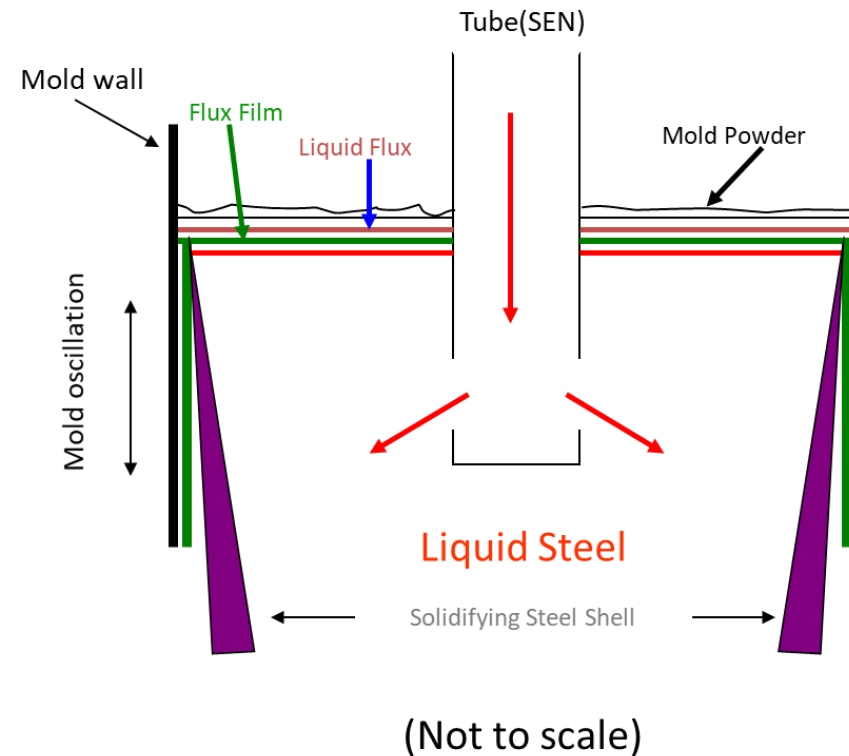

Steelmaking

Thin Slab Continuous Casting

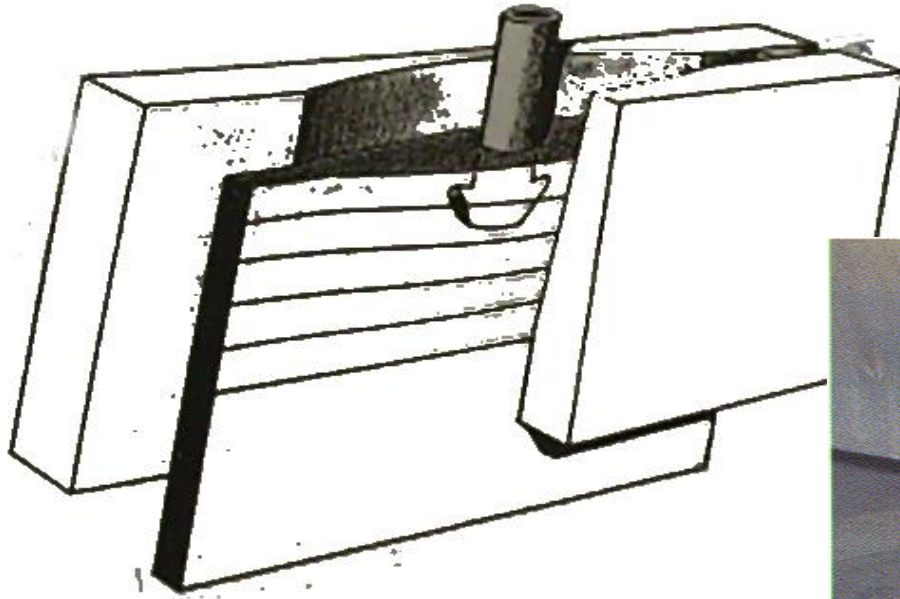

The curved mold was the technological breakthrough that allowed for thin slab casting!

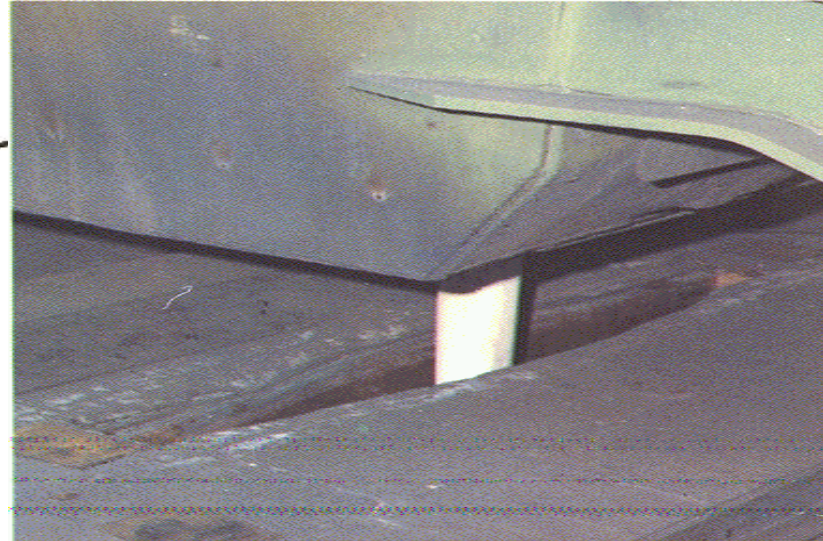

Source: Unknown

Integrated Steelmaking

Integrated production of Hot Bands

Hot Strip Mill

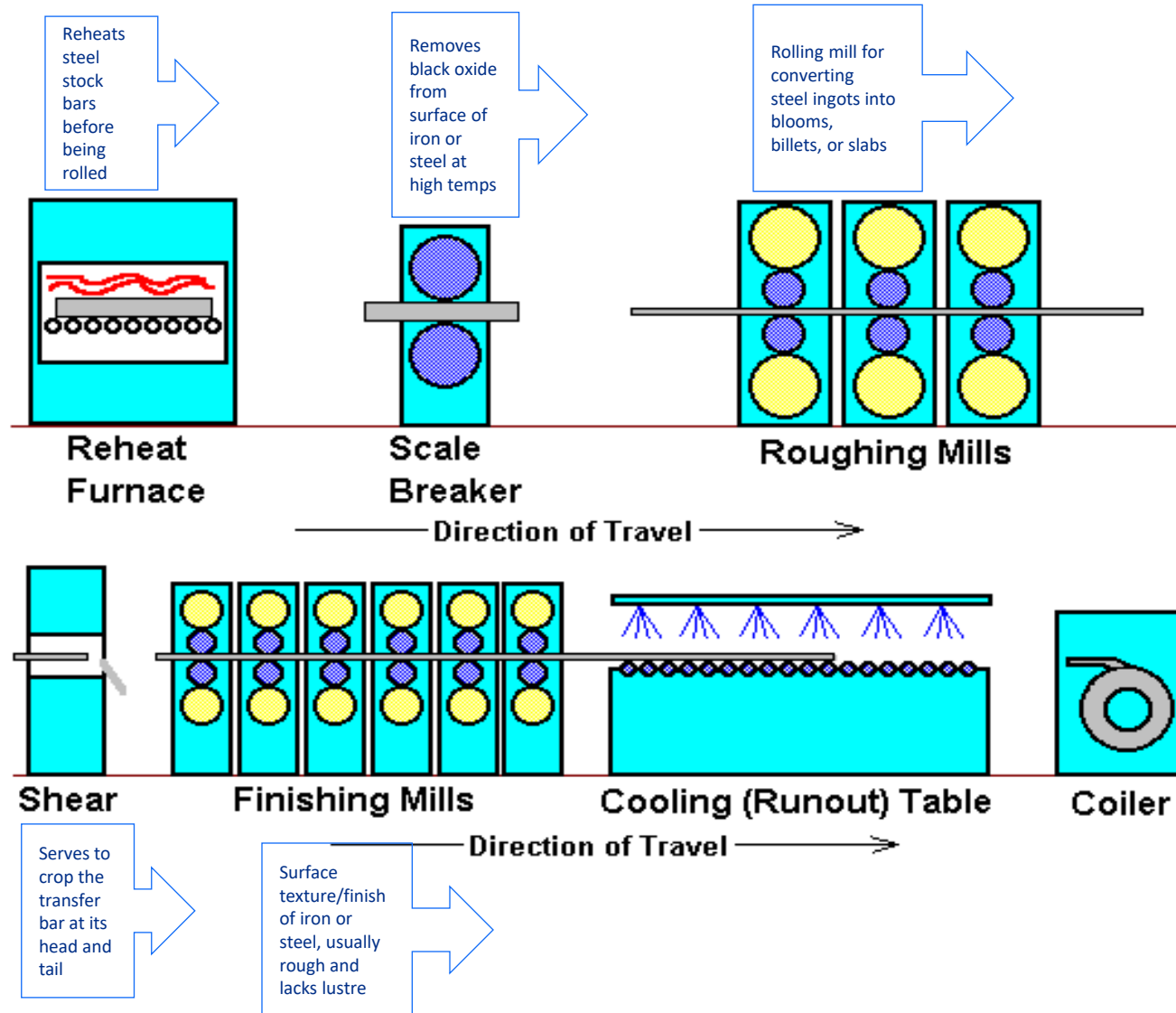

Mini-Mill Steelmaking

Process Flow

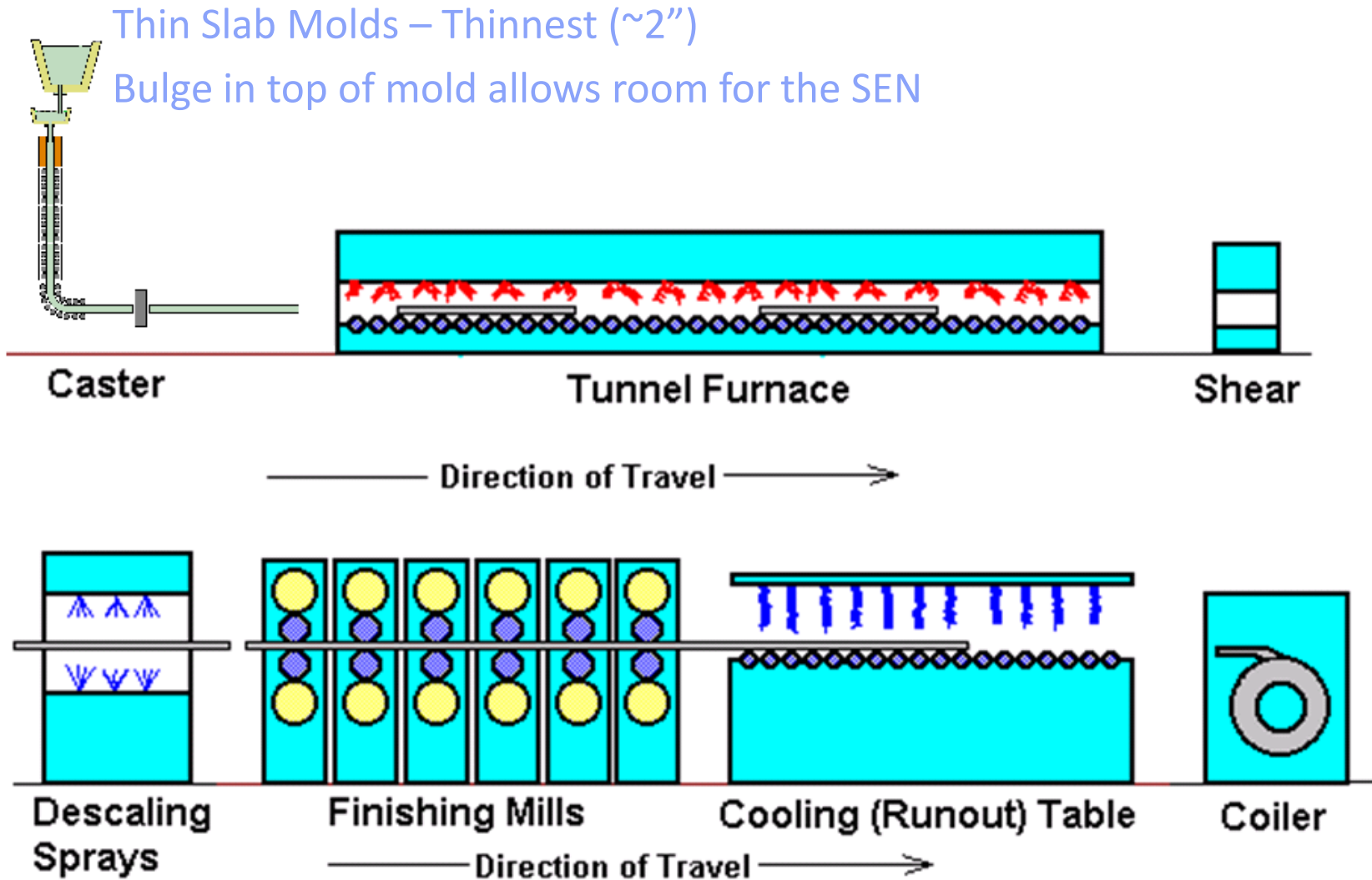

Integrated Steelmaking

Integrated Production of Hot Bands

- Purpose: Take slab from cast slab dimensions to prepare for finishing mills.
- Establishes crown and coil width.
- Generally the slab is twice the finished thickness.
- Austenite grains are deformed and re-crystalized with each rolling pass.

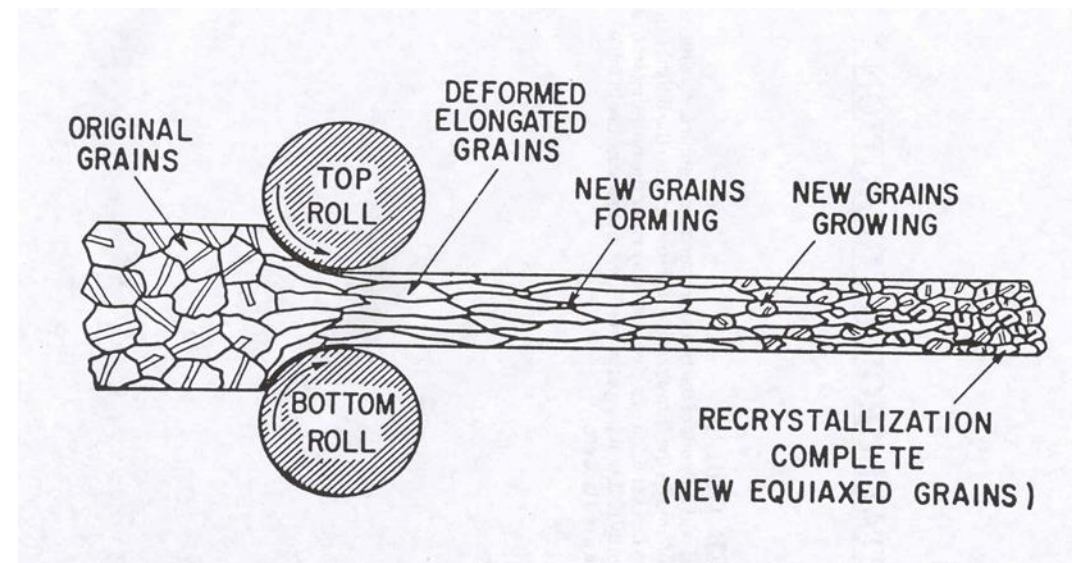

Integrated Steelmaking

Finishing Mills

Finishing mill temps

- Steel enters at 1950-1550°F
- Steel exits at 1750-1550°F

Temperature selected depends upon properties desired.

Determines shape and gauge.

Generally takes 6-7 mill stands to reduce to final gauge.

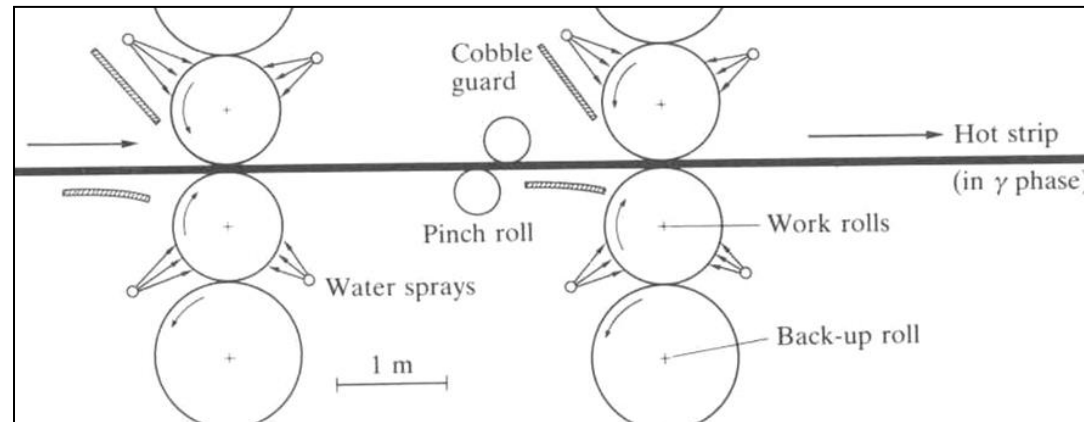

Source: Guthrie, Engr in Process Metallurgy

Integrated Steelmaking

The Coilers



- High temps produce coarse grains (1250-1300°F).
- Low temps produce smaller grains (1100-1200°F).
- Lower temps produce flat grains (950-1050°F).
- It depends upon the properties you want.

- The smaller the grain the harder the material.
- The larger the grain the softer the material.

The BIG Picture

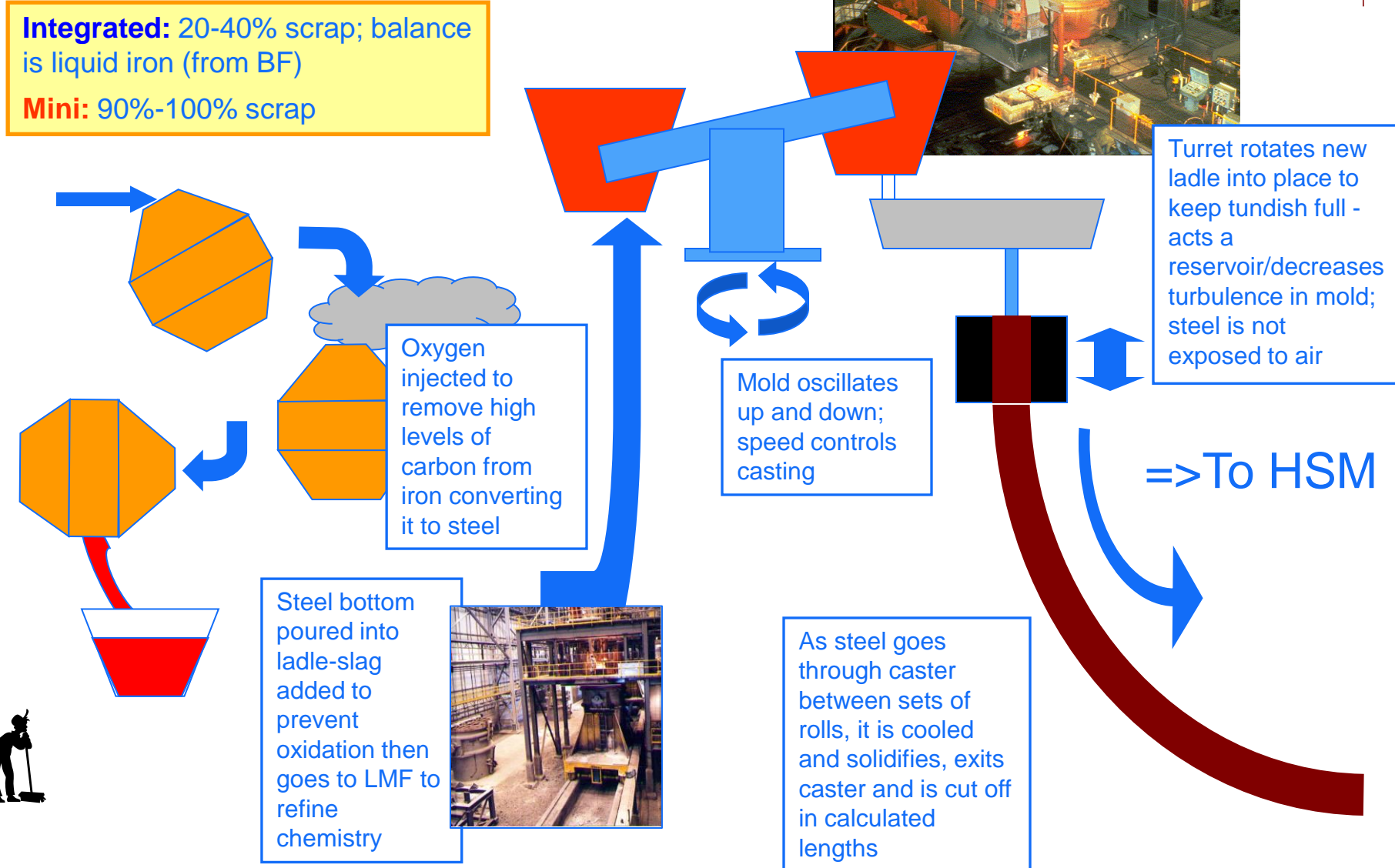

Integrated vs. Mini-mills

Cast Height – Higher cast height allows more time for NMI's to diffuse to top of mold

Slab Thickness – Thicker slab allows more time for solidification/NMI's to float to top

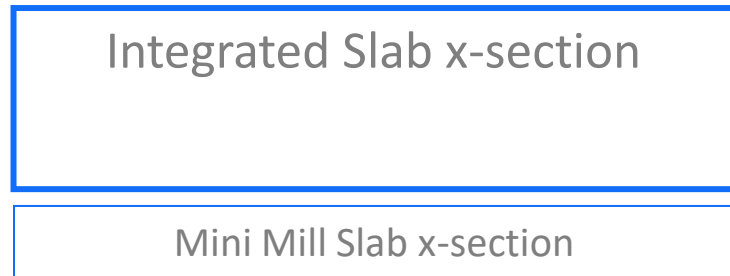
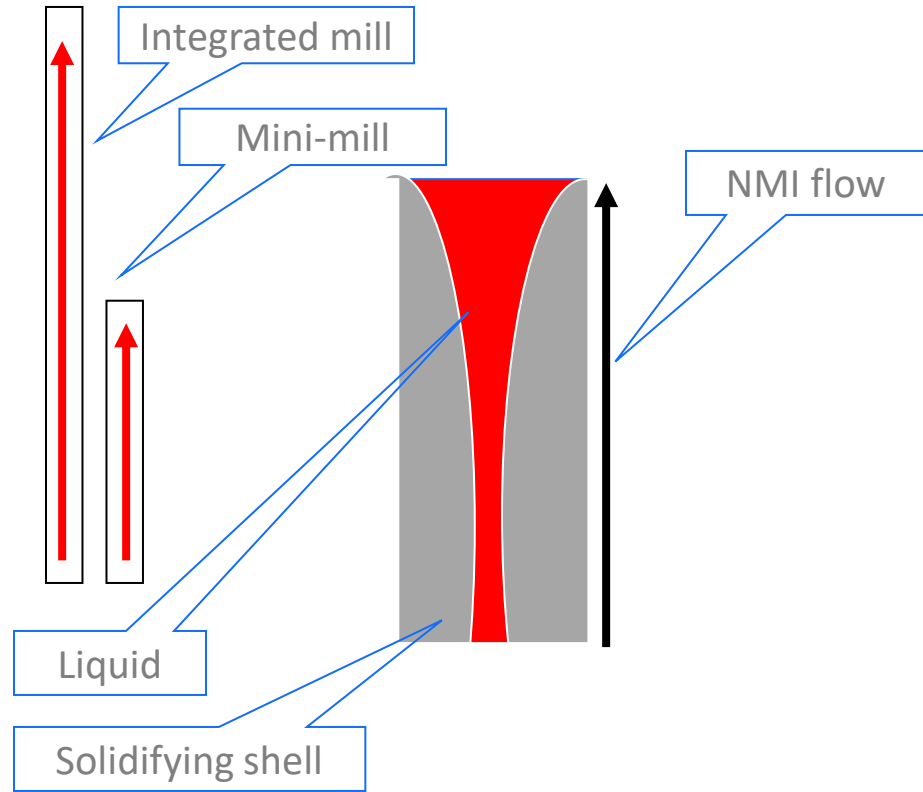

Area = length * width
Perimeter = 2 * (length + width)

Ex: given 90" wide mold
2" thick slab: x-section area=180sqin
perimeter = 184 "
9" thick slab: x-section area=810sqin
perimeter = 198"

Mini-mills have much larger surface area to internal volume ratio

Integrated vs. Mini-mills

HSM length – Integrated mills are much longer due to original slab size.

Slab Size – Integrated (8-10”); Mini-mills (2-5”)

Reheat Furnaces

- Integrated mills: Start of the process, often reheat slab from ‘cold’.
- Mini-mills: Integral part of process located immediately after caster, utilizes heat from casting process to save time, money.

Properties

- **Gauge:** Mini-mills have tighter gauge control as the slab rolls through the furnace so no cold spots are created as in integrated mills with walking beam and pusher type reheat furnaces where slab rests on a bar.
- **Crown:** Mini-mills have less crown due to thinner slab size and roll bending but as more integrated mills acquire that technology the difference is disappearing.

Integrated vs. Mini-mills

Slab reduction

- More reduction results in less cracking issues (HR only).
- Integrated product tends to have better surface due to greater reduction due to original slab thickness.
- Mini-mills have tendency to have caster folds from mold design difference which has higher potential for cracking the thicker the HR gauge.
- Mini-mill product has higher residual elements from using 100% scrap which leads to slightly higher hardness in HR product.

Formability differences

- Simple bends and shallow draws both are suitable.
- Both similar quality CR properties for most applications.
- Complex or deep draws, integrated substrate performs better.

What is a Lamination?

- A lamination is often detected by visual inspection.
- It appears as localized separating of steel; either present on flat surface or after forming, bending, cold reduction or stamping.
- Occurs when non-metallic inclusions (NMI) become entrapped under the surface of the steel.
- When enough NMI's are present then the steel is susceptible to splitting or laminating because NMI's weaken the grain boundaries.



Source: Worthington Steel

Common Sources of Lamination

Steelmaking

- Oxygen reacts with elements forming oxides which aren't 'trapped' by the slag
- Improper taping of ladle

Continuous Casting

- Liquid steel comes in contact with oxygen
- Improper mold practices
- Poor flux / casting practices

Hot Strip Mill

- Rolled over scratches
- Rolled in scale
- Poor side guide practices
- Frictional pickup during coiling of steel

Analysis of inclusion:

- Ladle Slag, Tundish Flux, Mold powder NMI's all have fairly distinct compositions
- HSM related NMI's usually form of iron oxide

Hot Strip Mill – Some Defect Causes

Possible sources for lamination and other related issues are mechanically caused entrapping oxides.

- Reheat Furnace – gouging on bottom surface
- Roughing Mills – rolled in scale and gouges
- Finishing Mills – rolled in scale and scratches
- Sideguides – damage side of slab
- Downcoilers – frictional pickup
- Roll Marks – imparted by work rolls
- Any frozen roll at HSM can impart scratch

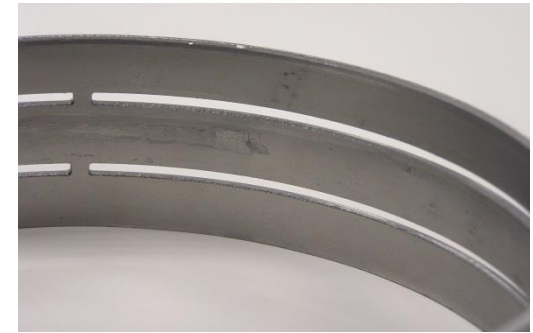

Source: Worthington Steel

Nonmetallic Inclusions

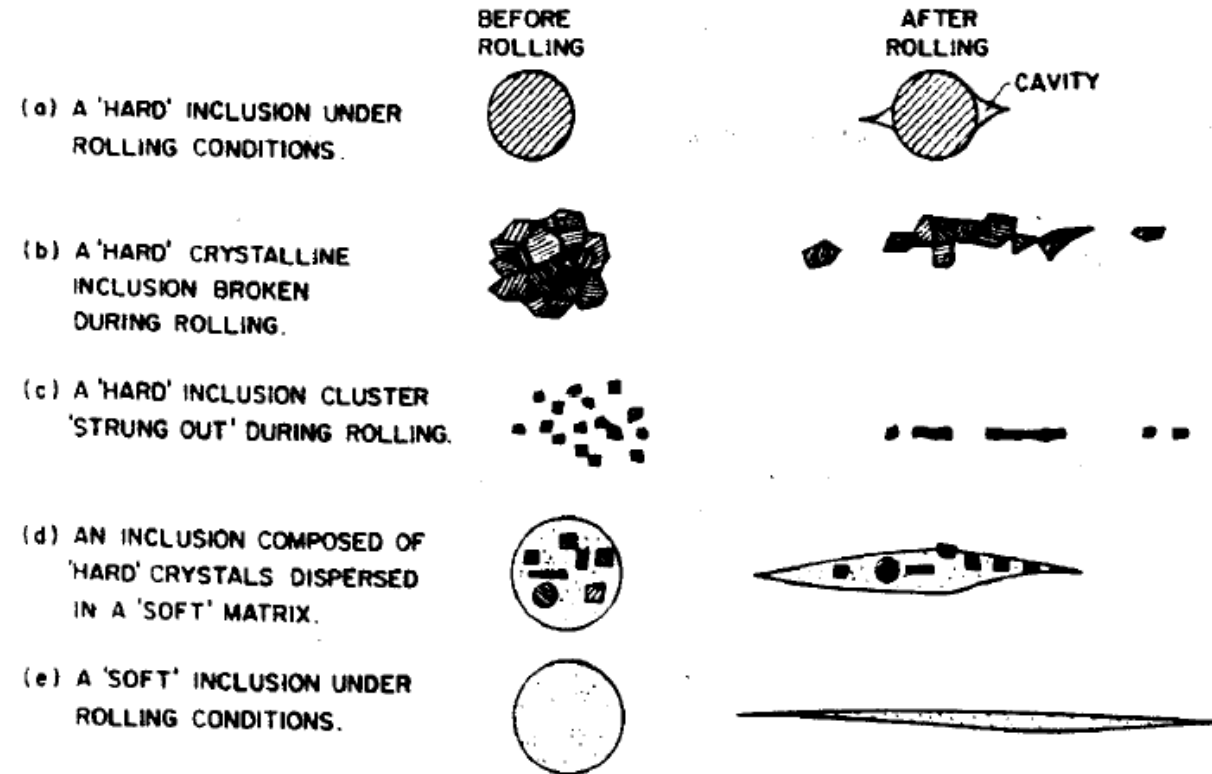

Fig. 3 Schematic representation of inclusions morphologies before and after deformation.

Basic Composition of Common Laminations

Common Oxides:

CaO, Al₂O₃, TiO₂, SiO₂, MnO, CrO₃



Decreasing Affinity for O₂

- Ladle Slag, Tundish Flux, Mold powder
NMI's all have fairly distinct compositions
- HSM related NMI's usually form of iron
oxide

FeO, Fe₂O₃ and/or Fe₃O₄

Section IV: Pickling

Pickling

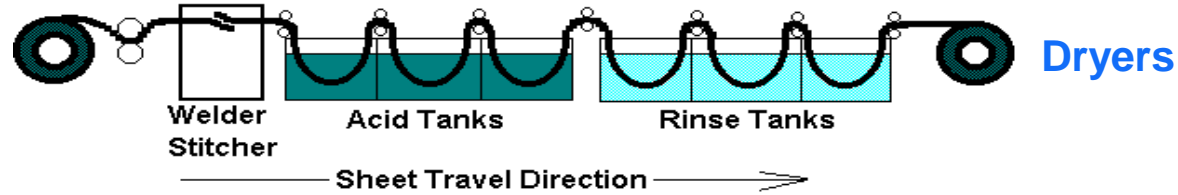

Source: [Worthington Steel](#)

Acid Tanks

Contain Hydrochloric Acid at an elevated temperature

Rinse Tanks

Deionized water spray to remove acid from strip surface

Dryer

Dry the strip to remove any chance of rust forming

Oiling

Oil is applied to top surface at down coiler on exit end of line and wrap to wrap transfer coats bottom surface.

Pickling is a metal surface treatment used to remove impurities, such as stains, inorganic contaminants, rust or scale from ferrous metals.

Pickling

Acid Pickling

- Remove surface scale on hot rolled coils prior to cold rolling or further processing
- Hot rolled coils are processed through an acid bath to produce a pickled (oiled) product free of surface scale and rust

Eco Pickling

- EPS = Eco Pickled Surface
- Mechanical vs Acid Scale Removal (environmentally friendly)
- Blasts surface of the black band with a slurry of steel grit and water

Continuous Pickling

- Coils are welded or 'stitched' together
- accumulating towers allow for constant line speed through pickling section, 800-1200 ft/min line speed
- Scheduling is limited by width, gauge and alloy

Push-Pull Pickling

- Coil is fed or 'pushed' through line until received into take-up (recoil) reel then 'pulled' through
- Slower line speed of 200-400 ft/min, but greater flexibility in scheduling and grades of steel that can be processed

Common Appearance and Causes of Staining



Appearance

- Light to dark brown; most often line stop related



- Black; longer line stops, less available oxygen so different type of oxide (heavier)



- Bluish; often related to rinse temperature, spray pressure

Causes

- Line Stops
- Rinse Temperature
- Spray Pressure
- Excessive Turbulence in the Rinse Bath

The Difference Between Rust and Stain

IF both are forms of oxidation what's the difference?

- Rust normally seen (Transit, water damage, pinpoint, condensation) is hydrated rust meaning water and oxygen are the catalyst for this type of orange rust which will continue as long as H₂O and O₂ are present.
- Stain, although a type of low temperature oxide (FeO or Fe₃O₄) which is formed on the bare steel surface as a result of dissolved oxygen in the water.
 - Bare steel surface is very active will prefer to 'grab' excess O₂ before reacting with H₂O.
 - This forms a stable oxide which will not 'grow' or get worse over time like 'normal' rust seen on steel.

Section V: Cold Rolling

Cold Rolling

Rolling metal at a temperature below the softening point of the metal to create strain hardening (*work-hardening*).

Same as cold reduction, except that the working method is limited to rolling.

Cold rolling changes the mechanical properties of strip and produces certain useful combinations of hardness, strength, stiffness, ductility and other characteristics known as tempers.

Why

- Produce gauges that are lighter than hot rolled steel
- Improve thickness tolerance
- Improve surface
- Improve shape
- Obtain a wide range of metallurgical properties

Cold Rolling

Cold Rolling Metallurgy

- During cold working...
 - Grains are elongated
 - The # of dislocations increase
- As a result...
 - The “textured” grains create an “anisotropic” material (properties vary with direction)
 - Yield and tensile strength increase
 - Elongation (ductility) decreases

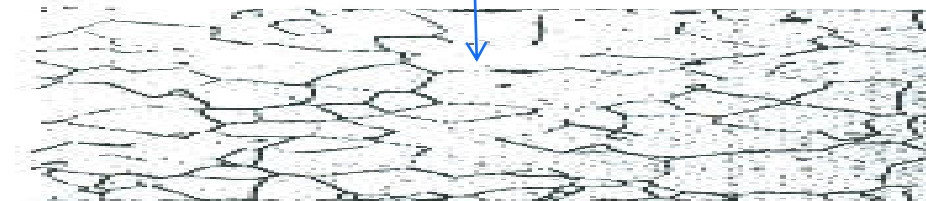
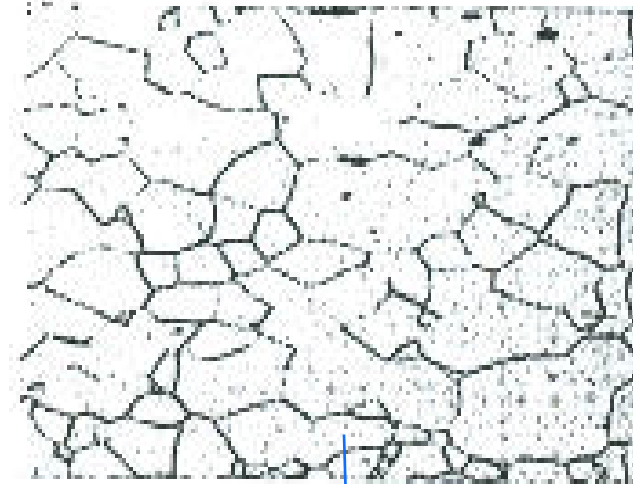

Cold Rolling

Types of Cold Mill Roll Configurations

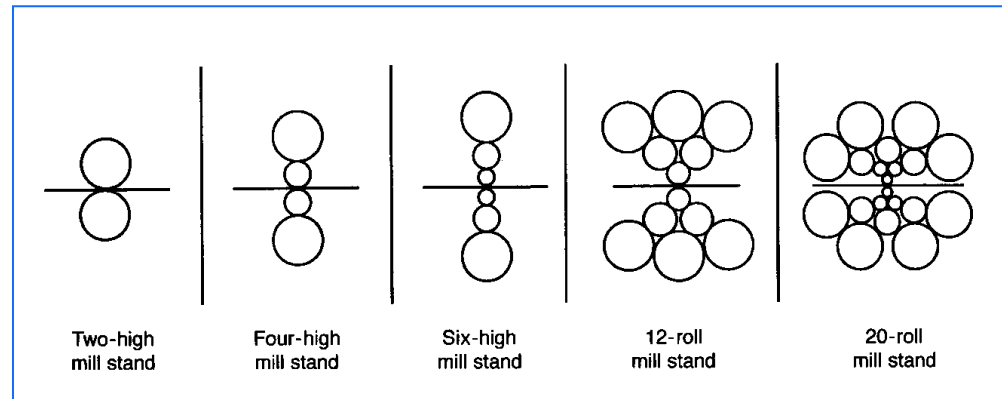

- The more rolls, the more well suited for heavy reductions on harder grades of steel offering tighter gauge control
- Can achieve very close gauge tolerances.
- Typically anything beyond a 4 high mill is used in stainless or red metals.

Cold Rolling

Three Stand Tandem Mill WS(Columbus)

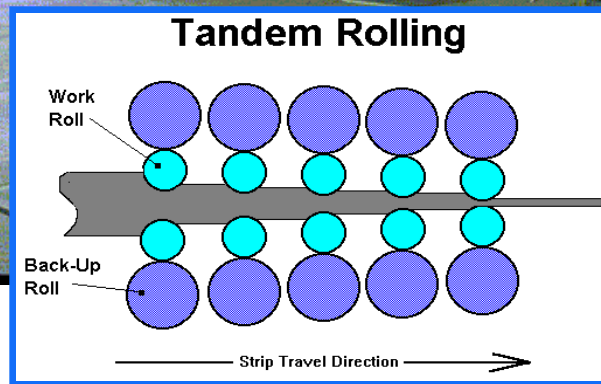
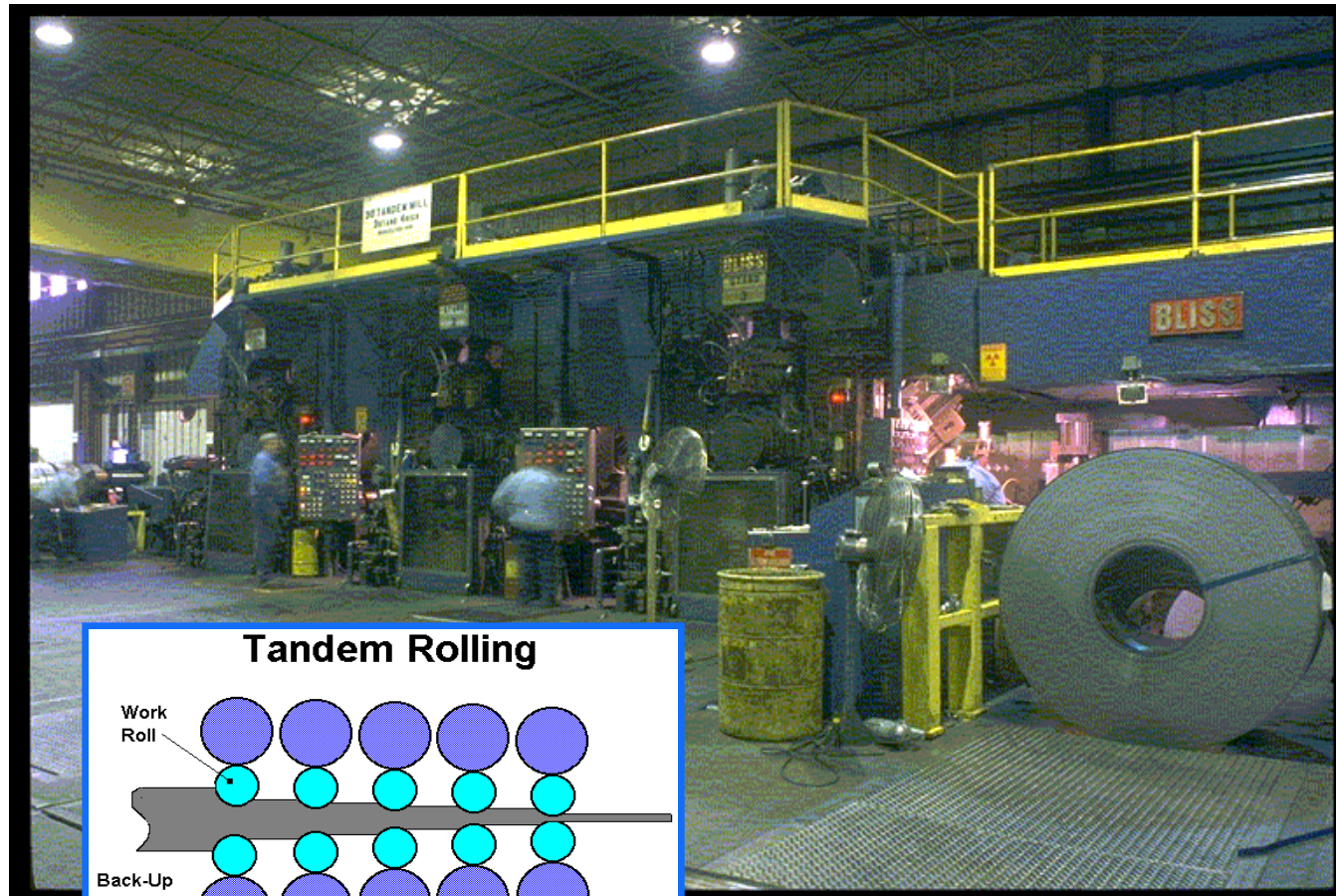

Cold Rolling

Reversing Mill WS(Columbus)

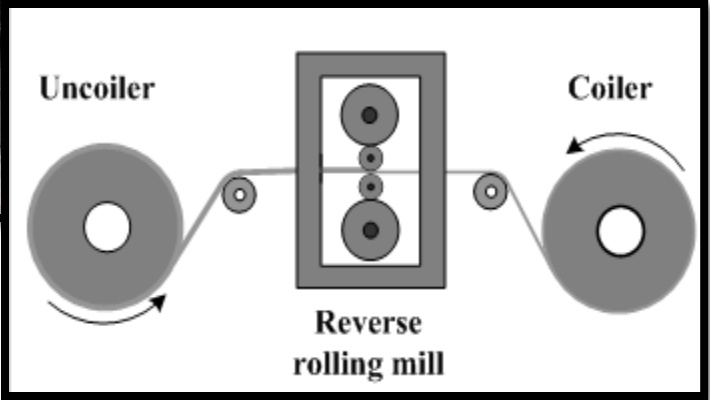
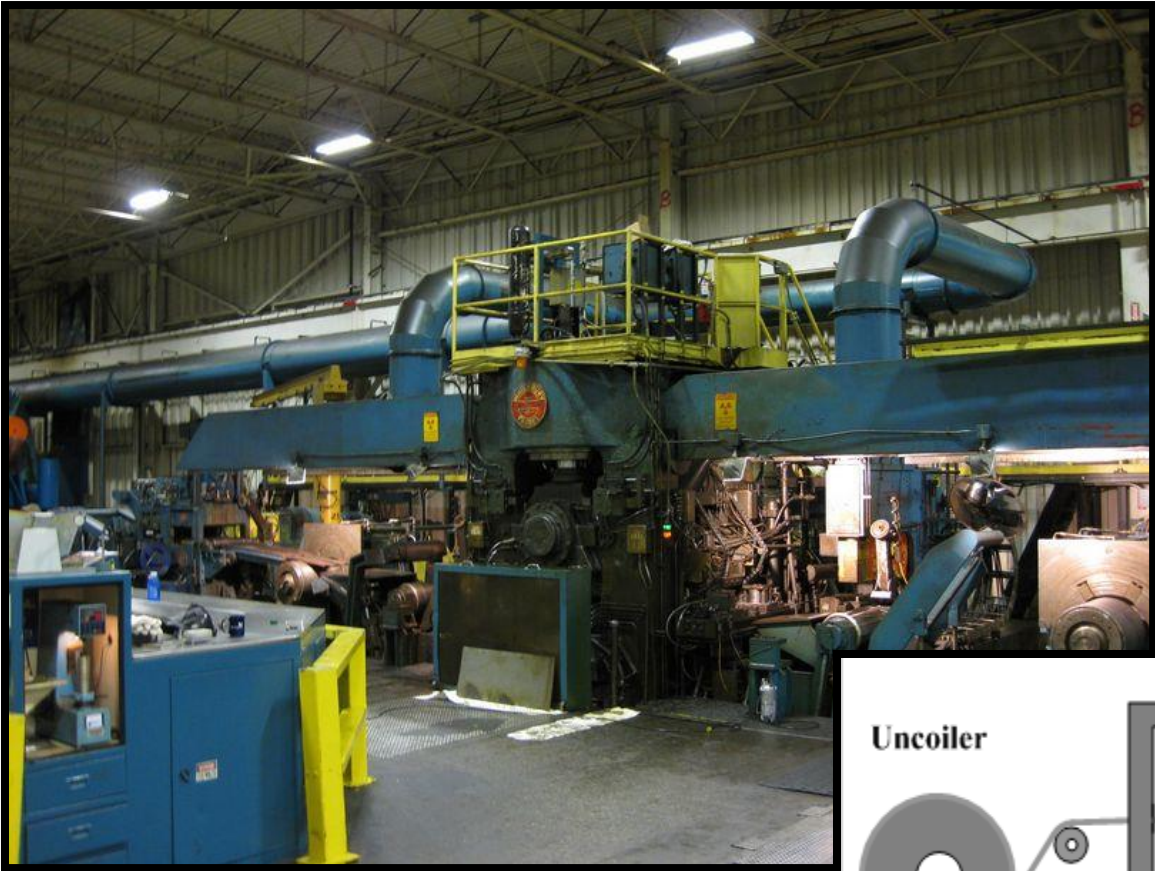

Cold Rolling

Types of Cold Mill Roll Configurations

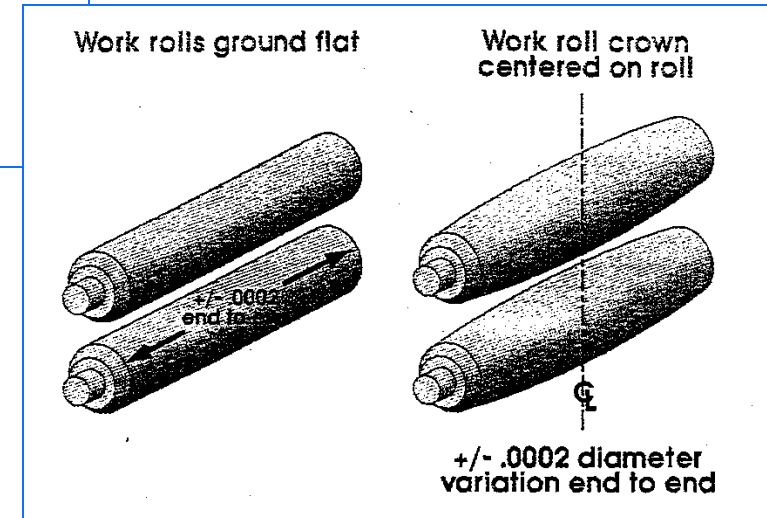
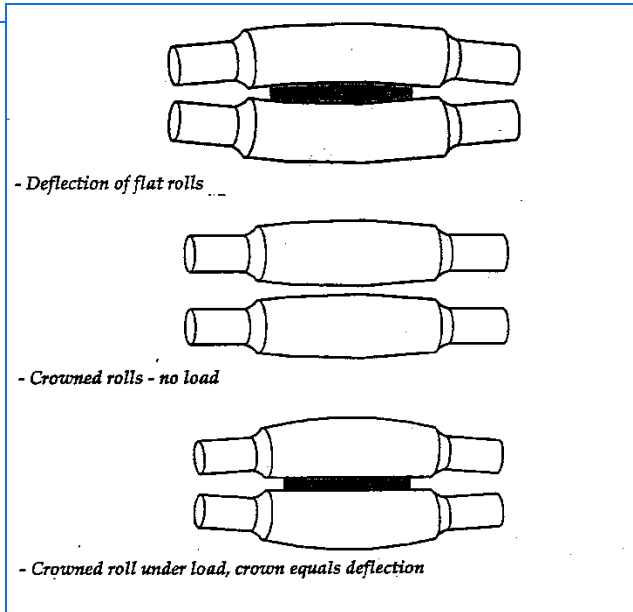
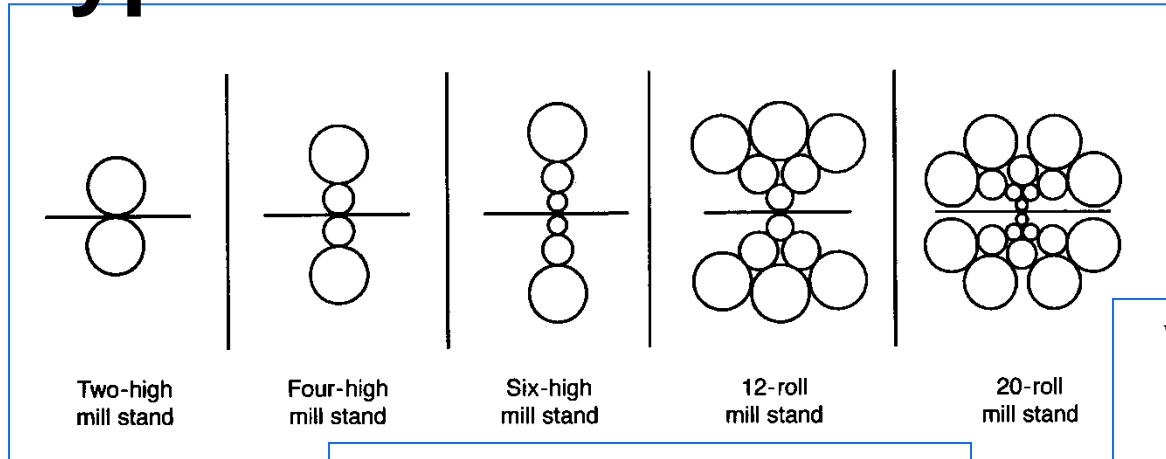

Cold Rolling

Cluster Mill

(Sendzimir mill, Z-mill)

- 1-2.5" work rolls.
- Work roll is backed up by 2 intermediate back-up rolls, which are backed up by 3 back-up rolls.
- Well suited for heavy reductions on harder grades of steel such as high silicon steels, stainless and high carbon steels.
- Can achieve very close gauge tolerances.

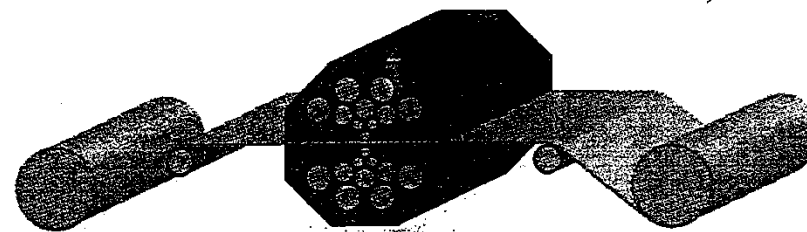
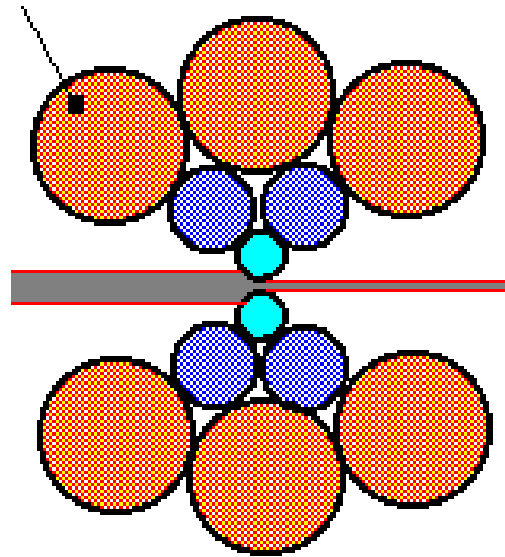

Strip Travel

Cold Rolling

Dislocations – What can cause steel to strengthen during Cold Rolling?

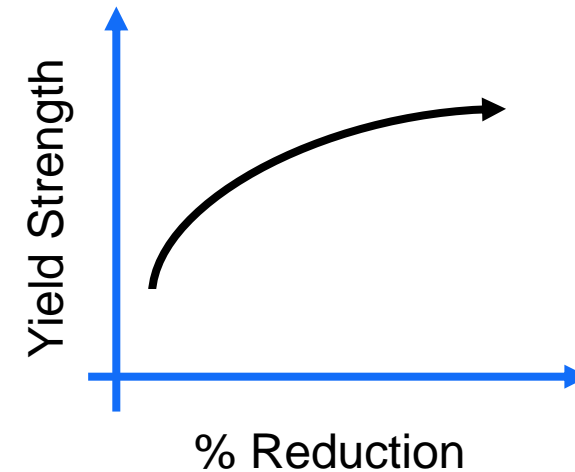
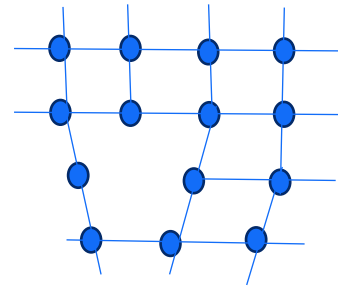
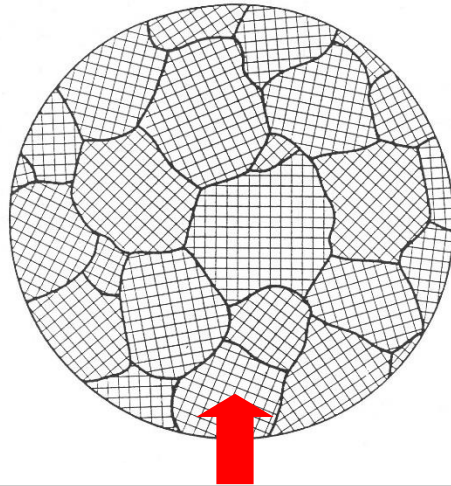

Original Grain structure
As material rolled,
dislocations (imperfections
in the structure) form
Overview of strip during
rolling increasing
hardness

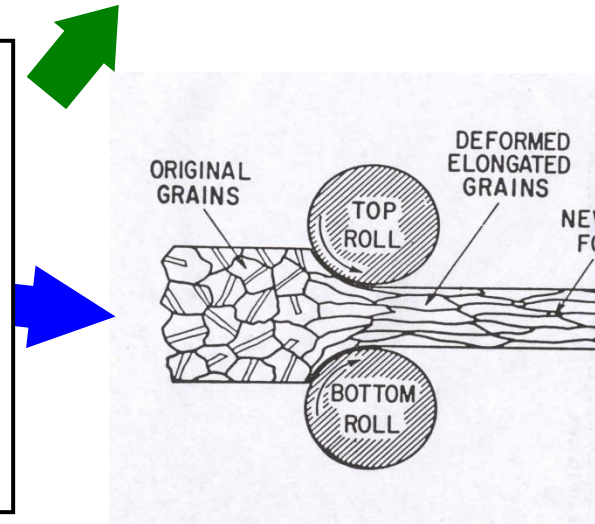

Note: Annealing
used to “relax” the
grain structure to
bring back ductility
of steel

Cold Rolling

Worthington's Own – One Pass

Fully Processed Cold Roll

More expensive than one-pass since more processing required

Presently real benefit seen in severe draw applications

Better gauge control than HR

refined physicals (grain structure, etc.)

Generally only slit edge available

One Pass

- Gauge tolerance same as CR +/- 0.002 ≤ 0.180", +/- 0.003 ≥ 0.180"
- Can provide different edge qualities (#4 round or #5 deburred) same as strip
- Around 25 RMS surface roughness
- Can provide matte surface (~60-70RMS) on temper (CR) rolled material.
- Up to 15% reduction obtain properties
- Depending on gauge, most tempers available
- Must be designated as Cold Roll one pass (CROP or OPCR)

Section VI: Annealing



Annealing

- Full hard cold rolled steel is annealed by heating to a specified temperature, holding for a specified length of time, and cooling
- Typical annealing temperatures are 1100 F to 1400 F.
- Steel is annealed in atmospheres that protect the steel from oxygen.
- Annealing softens the full hard cold reduced steel to produce improved mechanical properties.

Basic Types of Annealing:

Regular Batch Annealing

Coils heated in Hydrogen/Nitrogen atmosphere, susceptible to age hardening due to Nitrogen. Used for any application where drawn properties or spheroidization of carbides is desired.

Continuous Annealing

Hydrogen/Nitrogen atmosphere, similar to annealing in Galvanize line, consists of cleaning, rinse, drying sections as well as heat, holding (strip at anneal temp for 1-2 minutes) cooling sections. Advantage is speed, more uniform hardness values, can use cooling section to create martensitic steels (very high YS,TS). Continuously Annealed product is harder than Batch Annealed due to shorter time at temperature.

Benefits of hydrogen:

- Higher heat diffusivity
- More uniform properties
- Cleaner surface / less smut
- No nitrogen pickup at surface

Annealing

Batch/Bell

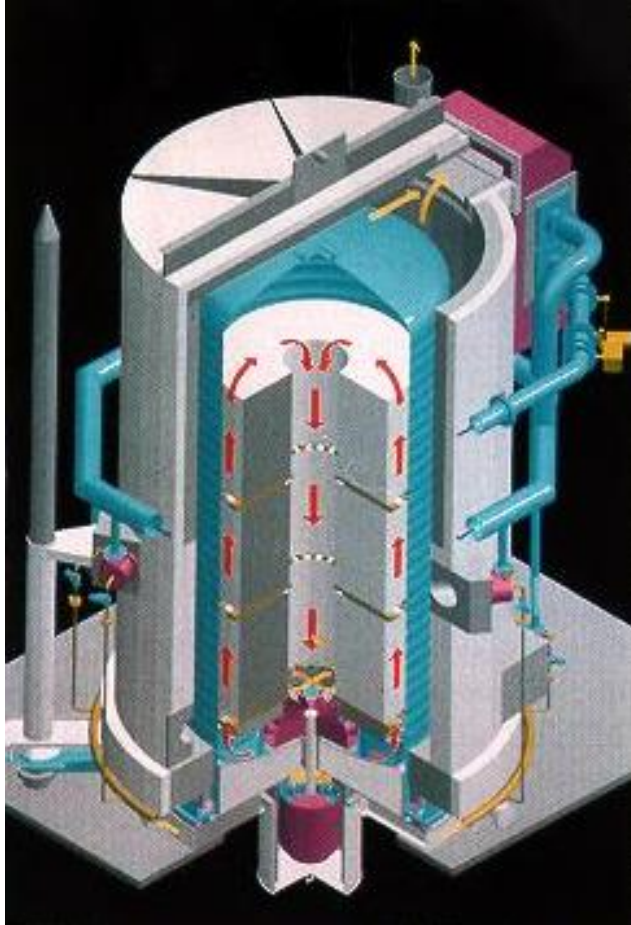

- During cold rolling, grains get stretched out and flattened resulting in harder, less ductile material.
- During anneal grains 'relax' regain their prior circular (equiaxed) shape and depending on annealing cycle grow in size.
- Longer Anneal => Softer Product
- Shorter Anneal => Harder Product
- Another use for annealing is to spheroidize (change from angular to circular) the carbides which makes stamping parts easier, especially high carbon steels (i.e. SAE 1030,1050) .

Annealing

Annealing Metallurgy

Recovery>Recrystallization>Grain Growth

Recrystallization

- New crystals form and consume the old grains
- Function of Time and Temperature
- Large change in mechanical properties

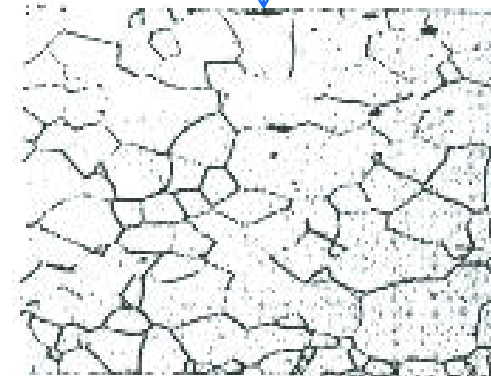
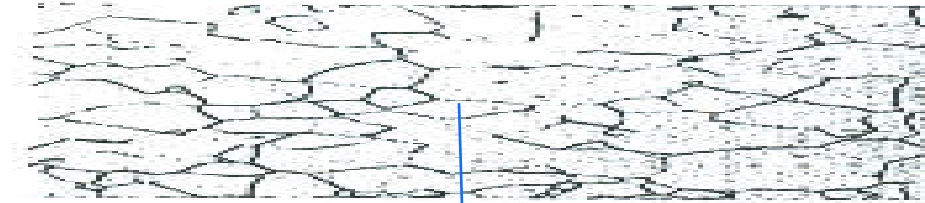

Grain Growth

- Large grains consume small grains
- Moderate change in mechanical properties

Section VI: Temper Rolling

Temper Rolling

- Improves shape
- Better surface
- Gauge correction
- Eliminates Luder lines
- Minimizes chance of coil breaks during further processing
- Reduces effect of camber during slitting

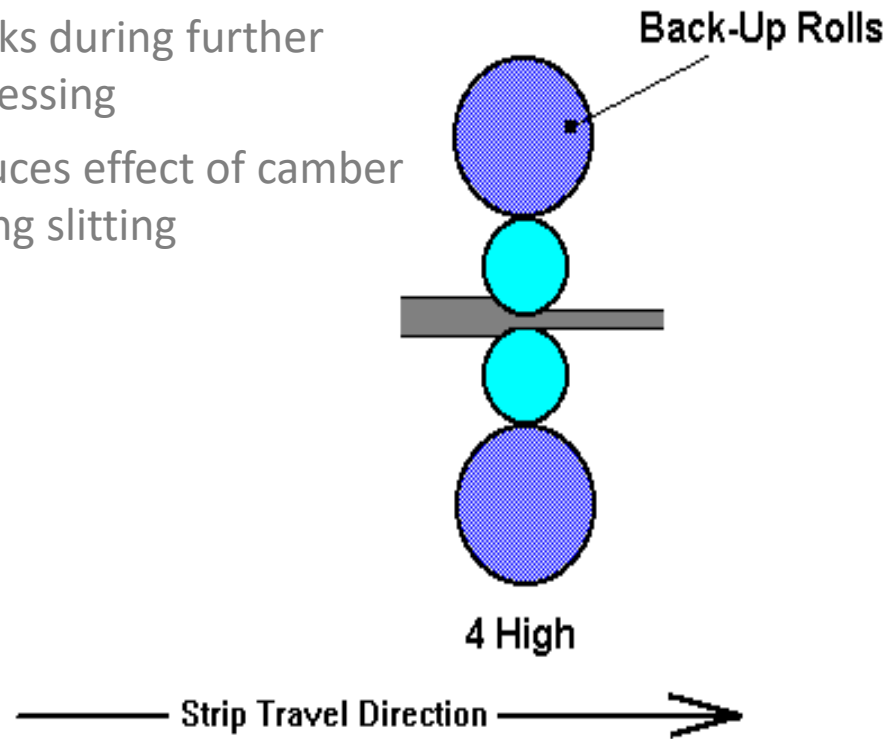

Luder Line Prevention

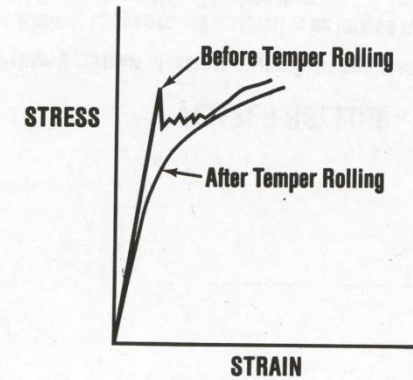

COIL BREAKS - CR



COIL BREAKS - HR

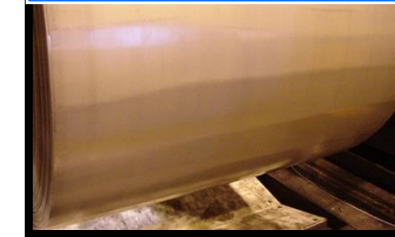

Temper Rolling

Shape Defects that leveling can correct:

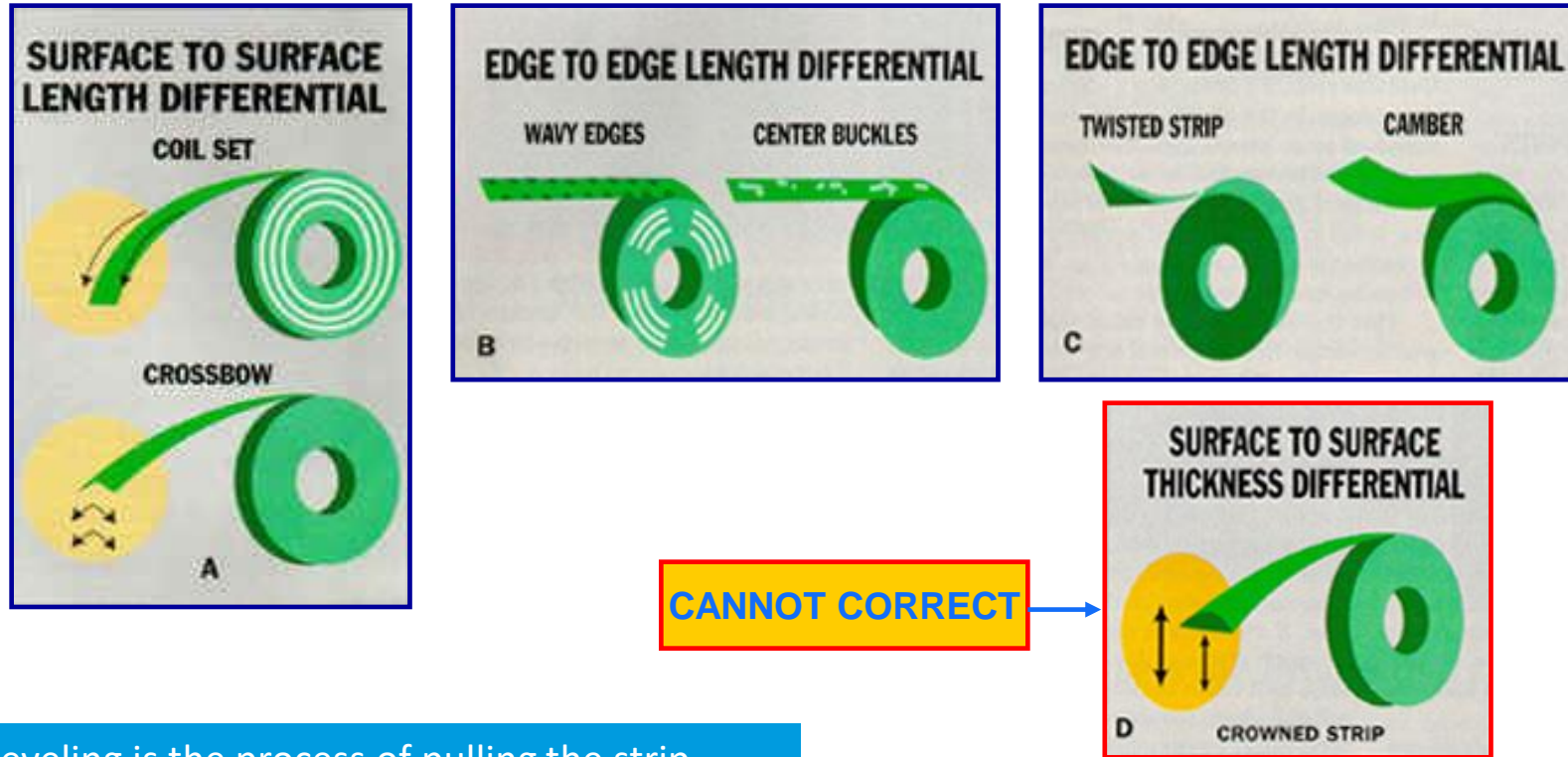

Tension Leveling is the process of pulling the strip beyond its yield point to permanently change the shape of the strip and make it flat; it's a combination of elongating the strip and bending the fibers.

Temper Rolling

When residual stresses left in steel, parts can bow even though pattern sheet appears flat

- We can test for this by cutting steel in smaller sections – either 12" x 1-2' or half jack distance (6" x ~2') depending on end use

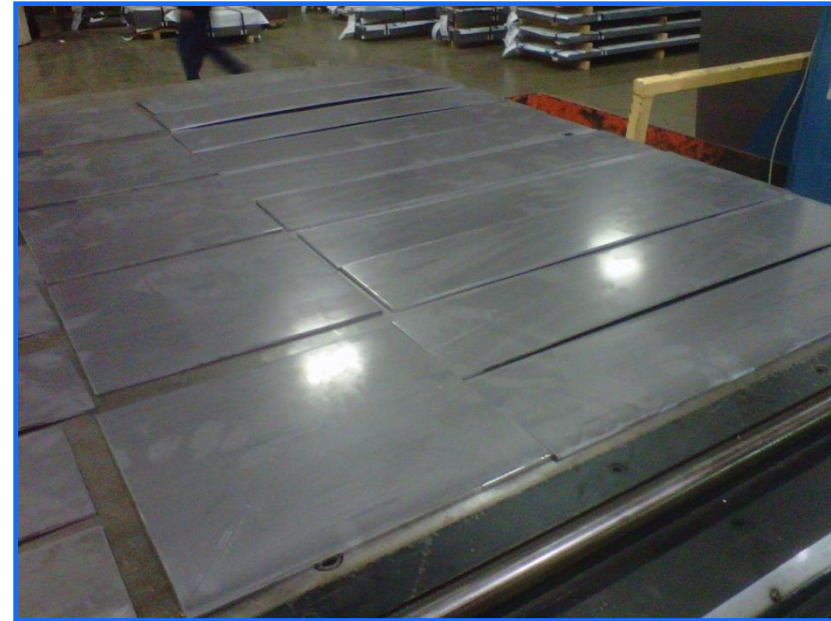

Section VII: Coated Products



Coated Products – Corrosion Protection

Barrier Protection

- All coatings protect the base metal by providing a shield from the environment

Galvanic Protection

- Coatings that offer cathodic protection to the steel substrate; also known as galvanic or sacrificial protection
- Prevent corrosion even if base metal is exposed



Coated Products – Corrosion Protection

Barrier Protection

- All coatings protect the base metal by providing a shield from the environment

Galvanic Protection

- Coatings that offer cathodic protection to the steel substrate; also known as galvanic or sacrificial protection
- Prevent corrosion even if base metal is exposed

Coated Products – Cathodic Protection

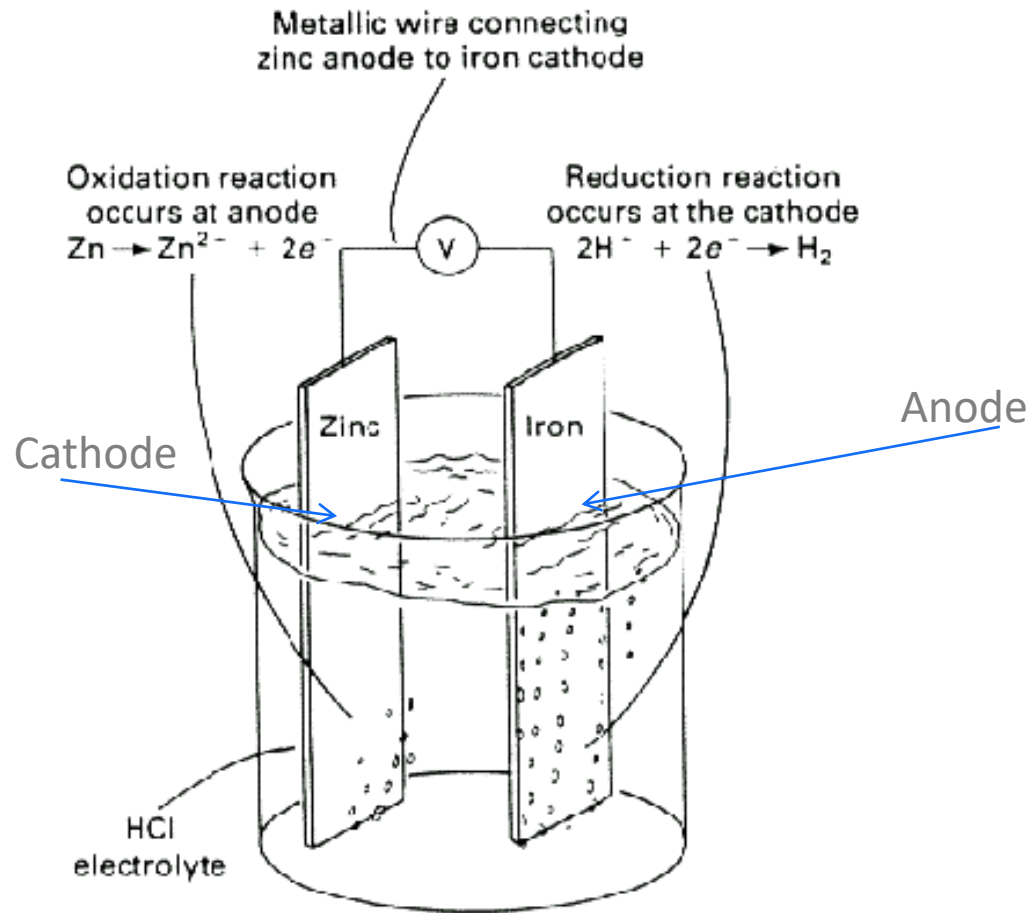

electro-chemical series

Potassium	-2.92
Calcium	-2.87
Sodium	-2.71
Magnesium	-2.37
Aluminium	-1.66
Zinc	-0.76
Iron	-0.44
Tin	-0.14
Lead	-0.13
Hydrogen	0.00
Copper	+0.34
Silver	+0.80
Mercury	+0.85
Gold	+1.68

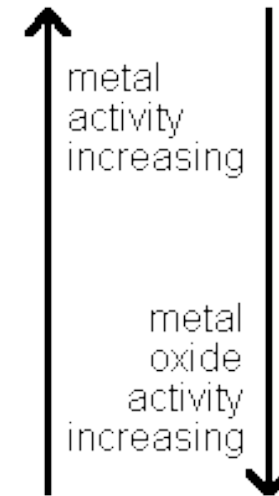

- When zinc coated steel is scratched, a local “galvanic cell” is formed
- This is also what protects the bare edges

Coated Products – HOT DIP GALVANIZING

Zinc Coating applied by passing the steel through a bath of molten zinc in a continuous operation.

Base substrate may be hot roll or full-hard cold roll. In-line continuous annealing.

Applications include corrugated pipe, construction materials, automotive, air-conditioning equipment, and farm machinery.

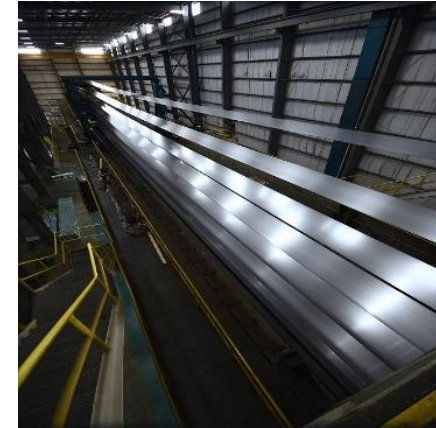

Coated Products – Aluminized Coating

- Steel that has been hot-dip coated on both sides with aluminum-silicon alloy.
- This process ensures a tight metallurgical bond between the steel sheet and its aluminum coating.
- A unique combination of materials is produced that neither steel nor aluminum possess alone.
- Aluminized steel shows a better behavior against corrosion.
- Two common types: T-1 (culvert applications and T-2 (heat resistant applications

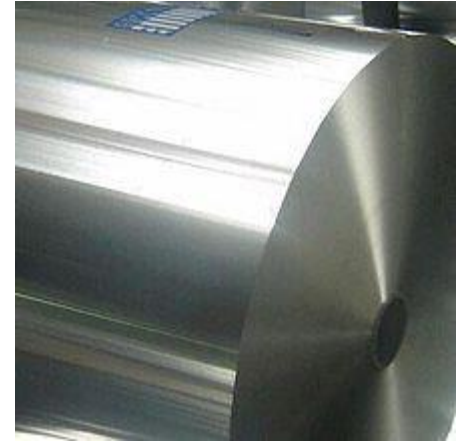

Credit: Creative Commons Attribution-Share Alike 3.0 Unported

Coated Products - Galvaneal

Applied using the hot-dip process.

After the steel leaves the molten zinc bath, it travels through an induction furnace.

The furnace heats the strip to greater than 900°F to diffuse iron from the steel into the zinc coating.



VS.

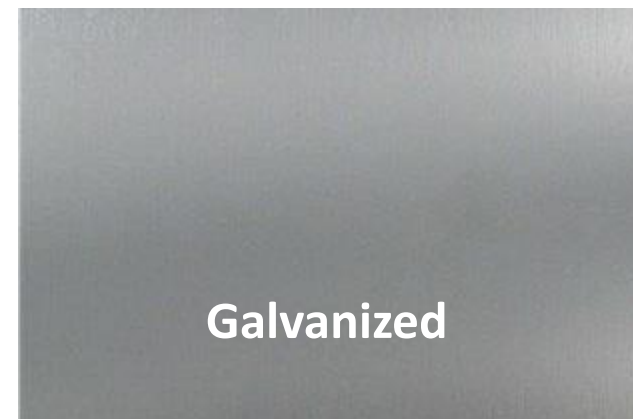

Coated Products – Galvanized Product Finishes

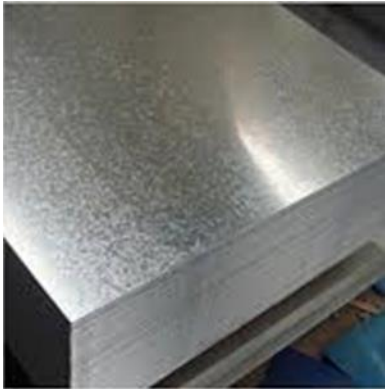

Spangle

- Crystalline appearance on surface
- Obtained by adding Lead or Antimony to the zinc bath
- Undesirable for painted applications
- WS Delta and Spartan produce a “spangle free” product

Coated Products – Galvanize Surface treatments

Coating weight: amount of zinc coating applied to a product for a given surface area.

Prevents “White Rust” - zinc oxide may form from moisture intrusion or condensation during shipment or storage.

Oil	Chromate (a.k.a. Chem Treat)	Acrylic	Phosphate
Rust preventative	Thin, relatively invisible, film of chromate	Chromate in a sealed organic polymer	Thick, dense, crystalline deposit of hydrated zinc phosphate
Also effective lubricant during forming	Superior in preventing white rust and maintaining the bright galvanized appearance	Fingerprint proof	Dull gray appearance
	Usually not compatible with most pre-treatments used on paint lines	Suitable primer for painted applications	Good adherent base for paint
	Hexavalent chrome is not RoHS compliant		

Section VIII: Slitting



Slitting

Slitting

- Master coils are cut (slit) to various widths by means of passing material through a tooling set-up called an arbor. The arbor sets the width of the material with precision hard-tooling spacers.
- Rubber stripper rings keep the strip flat and level
- The material is “cut” with high carbon alloy slitting knives which are off-set between the top and bottom arbors



Slitting

Anatomy of a Slit Edge

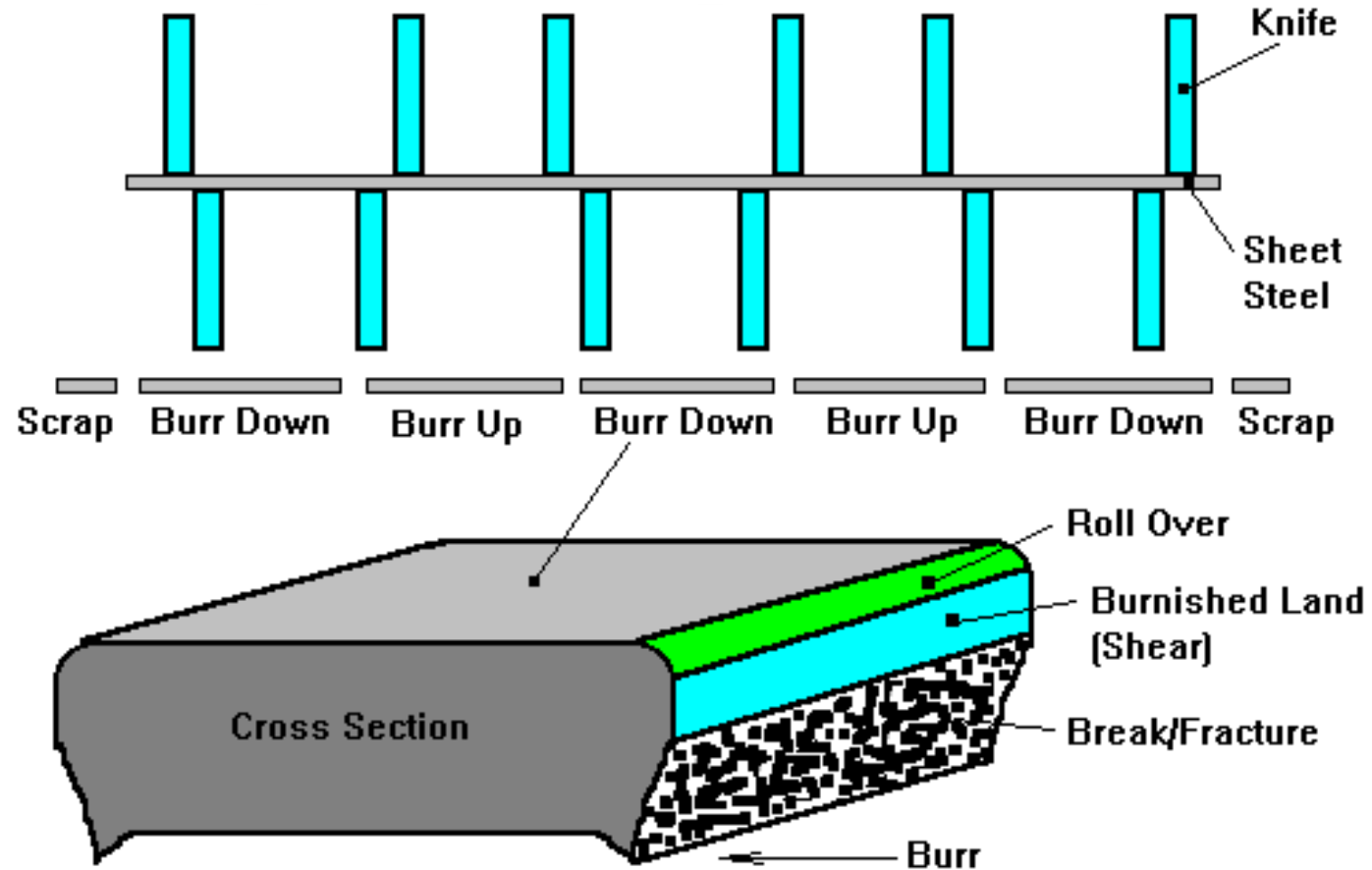

Slitting

Edge Types

Illustrations are examples only, actual edge profiles may vary from illustrations.



No. 1 Edge
(square)
Broken radial corners



No. 3 Edge
(slit)
Approximately square
Most Commonly Used



No. 1 Edge
(round)
Radius approximately equal
to 1/2 thickness



No. 4 Edge
(round)
Rounded corners – may be flat
with slitting fracture visible across
the edge

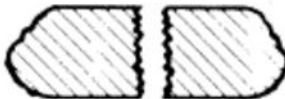

No. 2 Edge Natural
mill edge



No. 5 Edge
Approximately square
(No. 3 Edge de-burred)



No. 6 Edge
(square)
Radial corners – may have
slitting fracture visible across
the edge

Section IX: Testing



Steel Testing

Common Types of Steel Tests

n-value

R-bar/delta R

Superficial Hardness Testing

Tensile Testing

Surface Roughness Measurement

Charpy Test

- n-value, also known as the strain hardening exponent, is the measure of a metal's response to cold working.
- Tool & Die classes often reference value as approximation of material's "stretchability".
- Cold working is the plastic deformation of metal below its recrystallization temperature and this is used in many manufacturing processes primarily in stamping for flatroll steel.
- Typical low carbon cold Roll steel will have n value of ~.18 whereas EDDS (IF) cold roll steel will be above .20 so the higher n-value the more drawable the steel is.
- It has been found that the relationship between true stress and true strain of a material during cold working can be represented by the equation:

$$\sigma = K \epsilon^n$$

Source: Instron

Steel Testing

Common Types of Steel Tests

n-value

R-bar/delta R

Superficial Hardness Testing

Tensile Testing

Surface Roughness Measurement

Charpy Test

R-bar

- R-bar – measure a given material's resistance to thinning.
- Typically comes into play in Draw & Iron (D&I) products where it is important to understand how material and how consistent material will draw.
- Typical end use are fire extinguisher shells, two-piece cans, capacitors, etc.

Delta R

- Delta R is indicator of ability of material to exhibit non-earring behavior.
- The larger the delta, the larger the 'ears' or 'unevenness of the draw will be – also contingent on amt of draw.



Source: world Auto Steel



Source: world Auto Steel

Steel Testing

Common Types of Steel Tests

n-value

R-bar/delta R

Superficial Hardness Testing

Tensile Testing

Surface Roughness Measurement

Charpy Test



- Most common method to measure hardness and provides relative indication of hardness.
- Multiple scales depending on material hardness.
 - “B” and “C” most commonly used with HR,CR.
 - For light gauge sheet, the 30T test should be used (< 0.061cm).
- Hardness inaccuracy can increase if..
 - Too close to edge (< 0.635cm or ~ 0.25”)
 - Sample bent
 - Test too close to each other (min distance 0.318cm)
 - Use wrong scale
- At least 3 tests should be taken on one sample to get average result to eliminate using a bad test result.

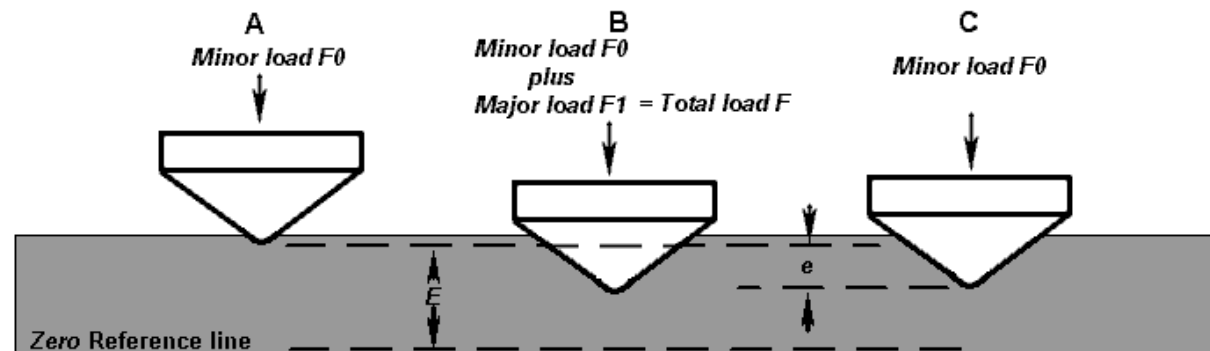

Steel Testing

Common Types of Steel Tests

n-value

R-bar/delta R

Superficial Hardness Testing

Tensile Testing

Surface Roughness Measurement

Charpy Test

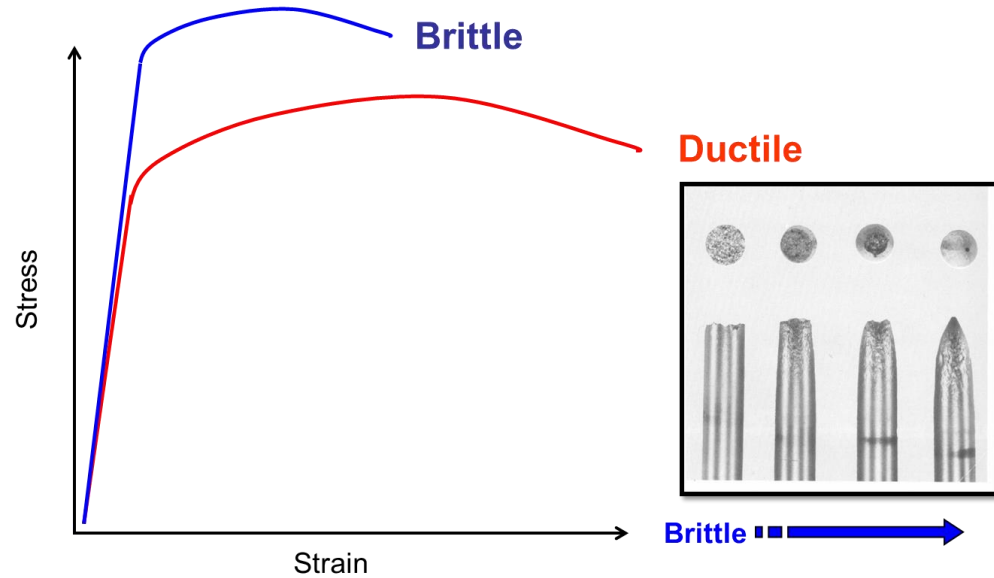

Tensile Strength

- Various Standards:

Ex: ASTM E8, JIS Z 2241, DIN EN ISO 6892-1

- Gives a measure of a variety of properties and that can be used to predict performance.

Ex: tensile strength, yield strength,
% elongation



Steel Testing

Common Types of Steel Tests

n-value

R-bar/delta R

Superficial Hardness Testing

Tensile Testing

Surface Roughness Measurement

Charpy Test

Ra: It is the average deviation of the profile from the mean line. However it doesn't differentiate between peak and valley height/depth(units-micro-inches)



Rz: More sensitive to surface roughness changes than Ra since measures roughness in 5 discrete sections

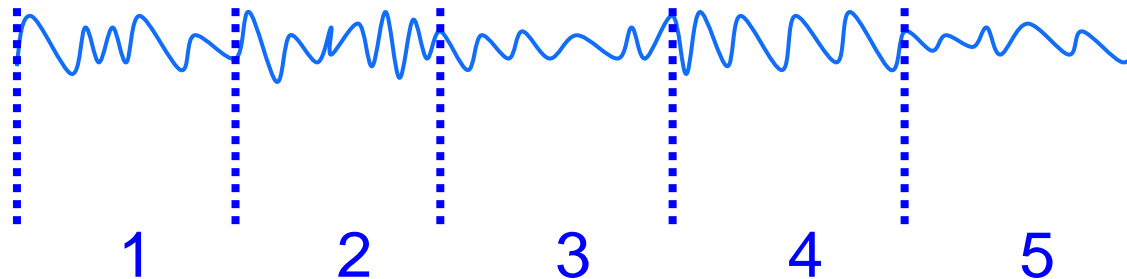

Steel Testing

Common Types of Steel Tests

n-value

R-bar/delta R

Superficial Hardness Testing

Tensile Testing

Surface Roughness Measurement

Charpy Test

- Invented in 1900
- Measures impact strength of materials
- Used in steel primarily for low temperature strength for rollover structures

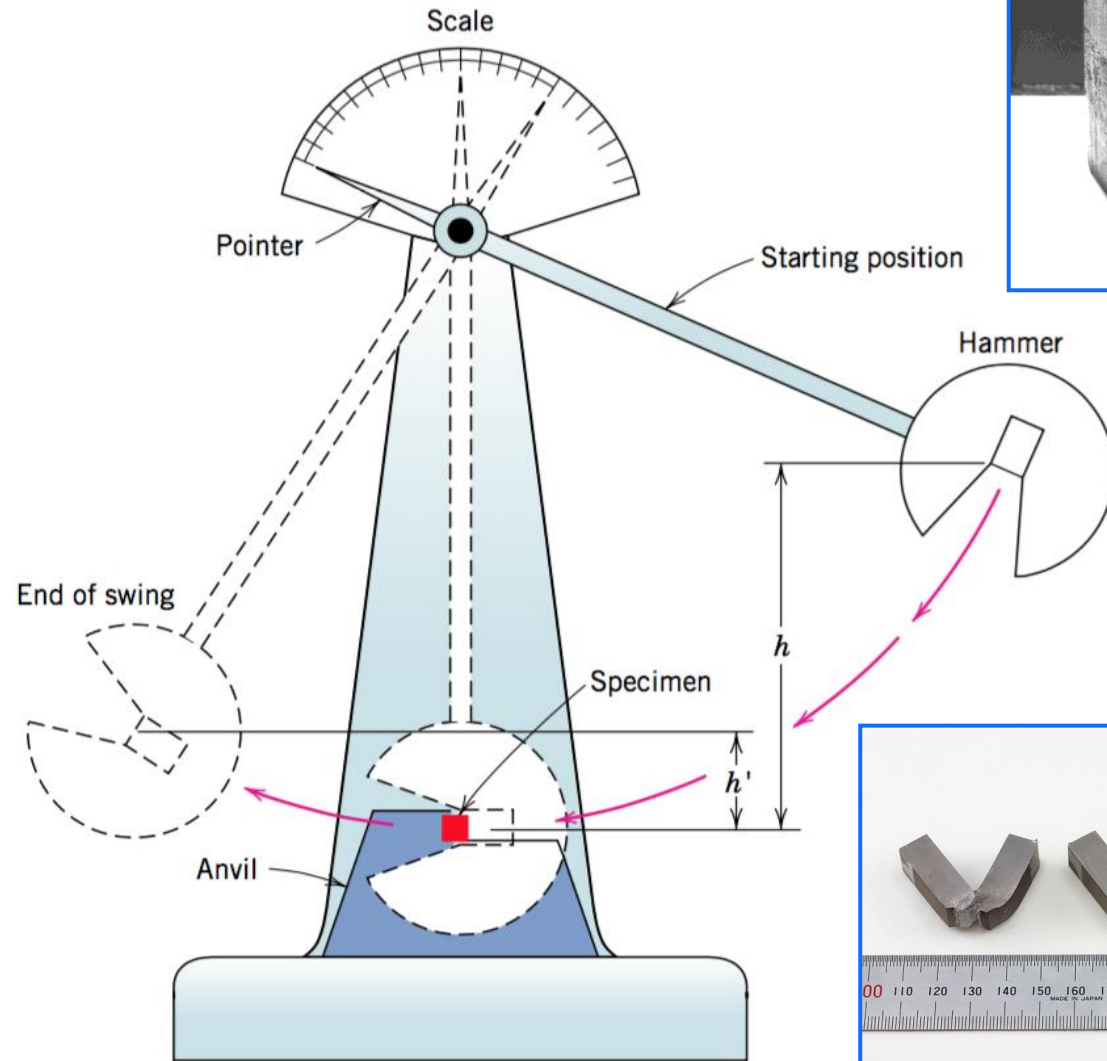

Statistics - General Overview

Average – value obtained by summing range and dividing by count of that range

$$(2+4+4+4+6+12+30)/7 = \text{Average}$$

Median – middle value in range of values

2 4 4 4 6 12 30

Mode – number that occurs most often

In this case it is 4, occurs 3 times

Outlier – number that is way out of normal data

30 looks like one but how can we tell if we have a lot of data?

Statistics - General Overview

One more tool...

Standard Deviation. Why??

Tells us how 'dispersed' our data is!

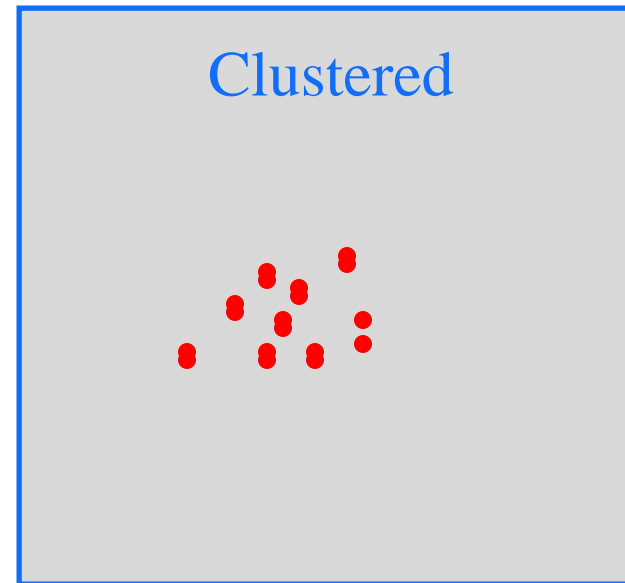
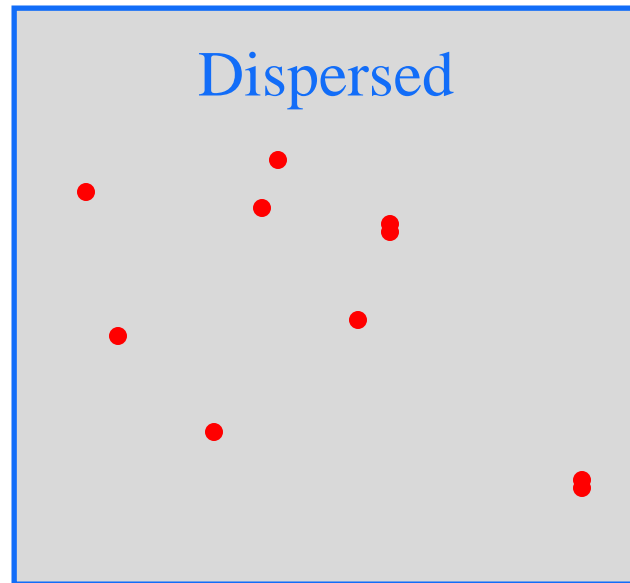

Statistics - General Overview

Standard deviation calculates where most of the data is!

It's handy when looking at mechanical properties, process parameters to see how accurately control process or where capabilities are.

So what is a standard deviation?

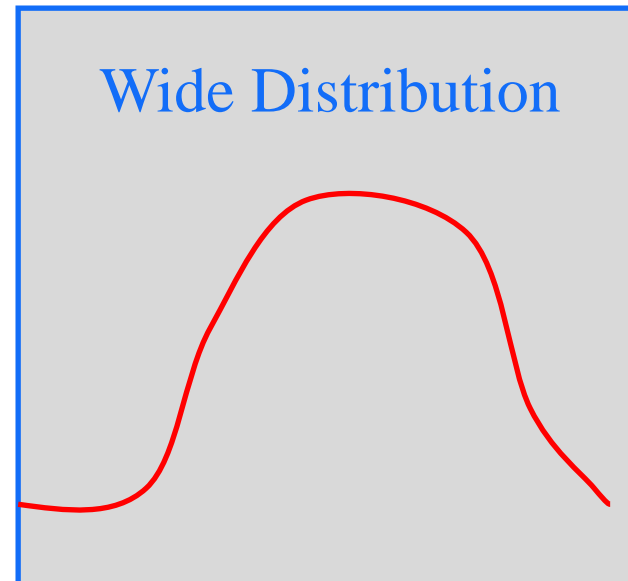
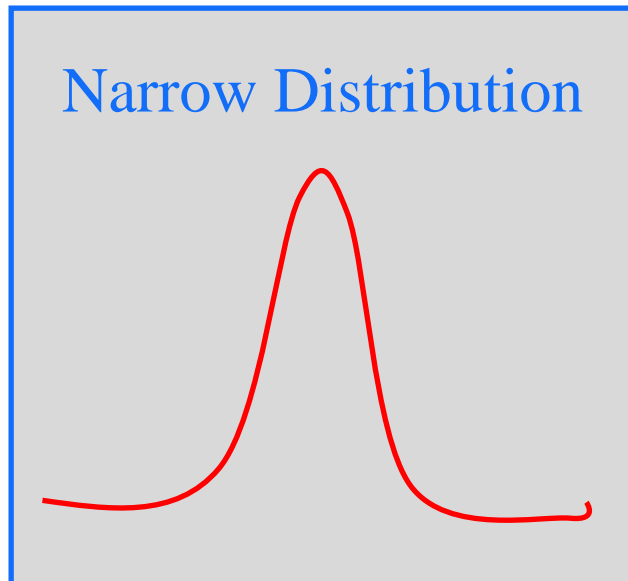

Statistics - General Overview

By one Standard deviation we mean 68% of data is within these points.

Example: Average of 10, std. deviations of +/- 3 implies 68% percent of data is within 7 to 13.

What about 2 std. deviations, or even three?
How much data does that include?...

Statistics - General Overview

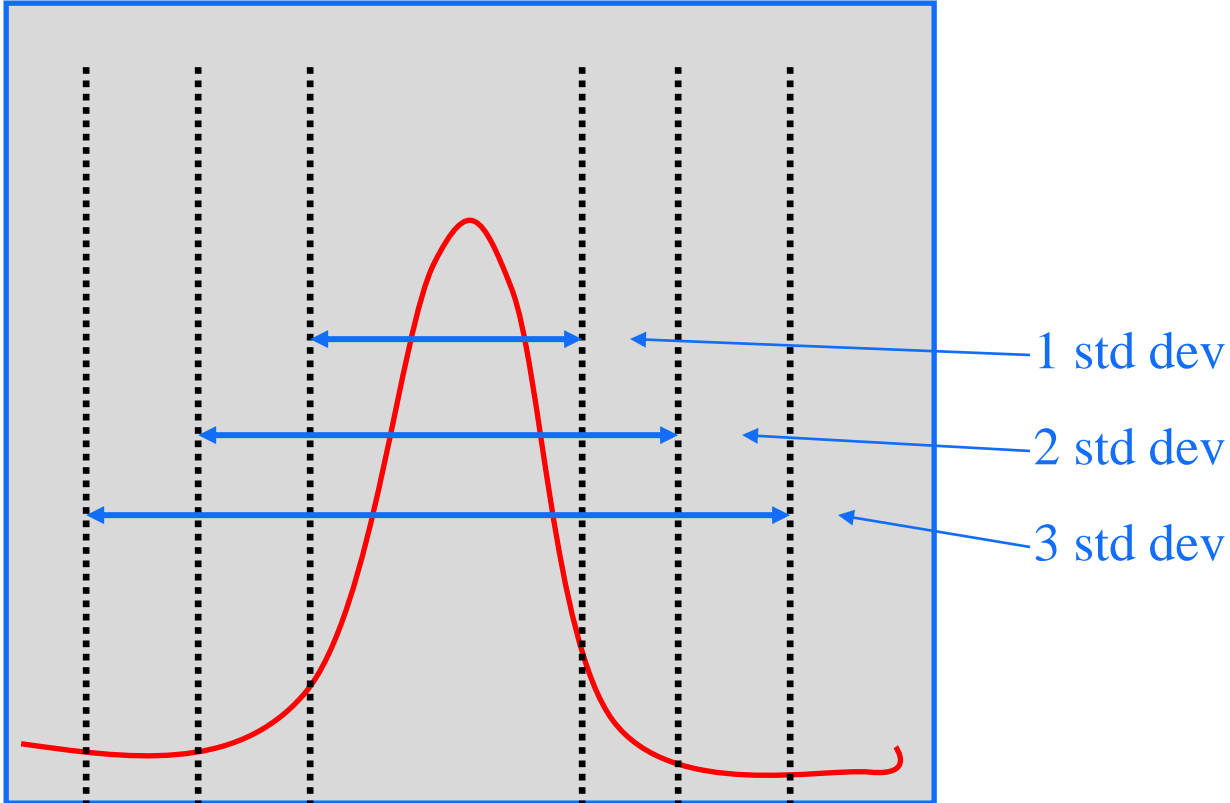

Statistics - General Overview

As you can see the further we go out less data is included... by a big amount!!

So,

One std. deviation includes 68% of data

Two std. deviations includes 95% of data

Three std. deviations includes 99% of data

Example: 99% of data in other example is between

$$\pm(3 \cdot 3) = \pm 9 \text{ or } 1 \text{ and } 19 \text{ (avg. } 10, \text{ std dev } 3)$$



Thank you.

www.worthingtonsteel.com/flatrolledsteel

